



Thyristor \ Diode Module

$V_{RRM} = 2 \times 1800 \text{ V}$

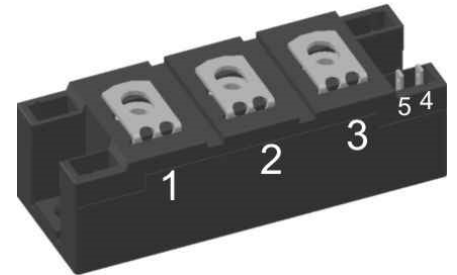
$I_{TAV} = 200 \text{ A}$

$V_T = 1,12 \text{ V}$

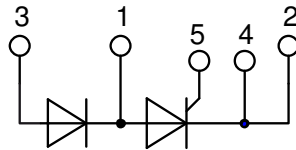
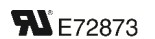
Phase leg

Part number

MCMA200PD1800YB



Backside: isolated



Features / Advantages:

- Thyristor for line frequency
- Planar passivated chip
- Long-term stability
- Direct Copper Bonded Al₂O₃-ceramic

Applications:

- Line rectifying 50/60 Hz
- Softstart AC motor control
- DC Motor control
- Power converter
- AC power control
- Lighting and temperature control

Package: Y4

- Isolation Voltage: 4800 V~
- Industry standard outline
- RoHS compliant
- Soldering pins for PCB mounting
- Base plate: DCB ceramic
- Reduced weight
- Advanced power cycling

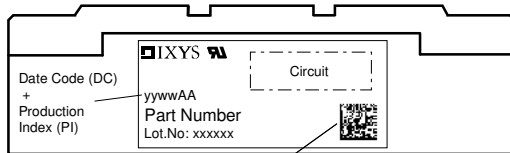
Disclaimer Notice

Information furnished is believed to be accurate and reliable. However, users should independently evaluate the suitability of and test each product selected for their own applications. Littelfuse products are not designed for, and may not be used in, all applications. Read complete Disclaimer Notice at www.littelfuse.com/disclaimer-electronics.

Thyristor				Ratings			
Symbol	Definition	Conditions	min.	typ.	max.	Unit	
$V_{RSM/DSM}$	max. non-repetitive reverse/forward blocking voltage	$T_{VJ} = 25^{\circ}C$			1900	V	
$V_{RRM/DRM}$	max. repetitive reverse/forward blocking voltage	$T_{VJ} = 25^{\circ}C$			1800	V	
I_{RD}	reverse current, drain current	$V_{R/D} = 1800 V$	$T_{VJ} = 25^{\circ}C$		300	μA	
		$V_{R/D} = 1800 V$	$T_{VJ} = 125^{\circ}C$		10	mA	
V_T	forward voltage drop	$I_T = 200 A$	$T_{VJ} = 25^{\circ}C$		1,17	V	
		$I_T = 400 A$			1,40	V	
		$I_T = 200 A$	$T_{VJ} = 125^{\circ}C$		1,12	V	
		$I_T = 400 A$			1,41	V	
I_{TAV}	average forward current	$T_C = 85^{\circ}C$	$T_{VJ} = 140^{\circ}C$		200	A	
$I_{T(RMS)}$	RMS forward current	180° sine			315	A	
V_{T0}	threshold voltage	} for power loss calculation only	$T_{VJ} = 140^{\circ}C$		0,83	V	
r_T	slope resistance				1,43	m Ω	
R_{thJC}	thermal resistance junction to case				0,17	K/W	
R_{thCH}	thermal resistance case to heatsink			0,09		K/W	
P_{tot}	total power dissipation		$T_C = 25^{\circ}C$		680	W	
I_{TSM}	max. forward surge current	$t = 10 \text{ ms}; (50 \text{ Hz}), \text{ sine}$	$T_{VJ} = 45^{\circ}C$		6,00	kA	
		$t = 8,3 \text{ ms}; (60 \text{ Hz}), \text{ sine}$	$V_R = 0 V$		6,48	kA	
		$t = 10 \text{ ms}; (50 \text{ Hz}), \text{ sine}$	$T_{VJ} = 140^{\circ}C$		5,10	kA	
		$t = 8,3 \text{ ms}; (60 \text{ Hz}), \text{ sine}$	$V_R = 0 V$		5,51	kA	
I^2t	value for fusing	$t = 10 \text{ ms}; (50 \text{ Hz}), \text{ sine}$	$T_{VJ} = 45^{\circ}C$		180,0	kA ² s	
		$t = 8,3 \text{ ms}; (60 \text{ Hz}), \text{ sine}$	$V_R = 0 V$		174,7	kA ² s	
		$t = 10 \text{ ms}; (50 \text{ Hz}), \text{ sine}$	$T_{VJ} = 140^{\circ}C$		130,1	kA ² s	
		$t = 8,3 \text{ ms}; (60 \text{ Hz}), \text{ sine}$	$V_R = 0 V$		126,3	kA ² s	
C_J	junction capacitance	$V_R = 400V \quad f = 1 \text{ MHz}$	$T_{VJ} = 25^{\circ}C$		273	pF	
P_{GM}	max. gate power dissipation	$t_p = 30 \mu s$	$T_C = 140^{\circ}C$		120	W	
		$t_p = 500 \mu s$			60	W	
P_{GAV}	average gate power dissipation				8	W	
$(di/dt)_{cr}$	critical rate of rise of current	$T_{VJ} = 140^{\circ}C; f = 50 \text{ Hz}$ repetitive, $I_T = 600 A$			100	A/ μs	
		$t_p = 200 \mu s; di_G/dt = 0,5 A/\mu s;$ $I_G = 0,5A; V_D = \frac{2}{3} V_{DRM}$ non-repet., $I_T = 200 A$			1000	A/ μs	
$(dv/dt)_{cr}$	critical rate of rise of voltage	$V_D = \frac{2}{3} V_{DRM}$ $R_{GK} = \infty$; method 1 (linear voltage rise)	$T_{VJ} = 140^{\circ}C$		1000	V/ μs	
V_{GT}	gate trigger voltage	$V_D = 6 V$	$T_{VJ} = 25^{\circ}C$		2,5	V	
			$T_{VJ} = -40^{\circ}C$		2,6	V	
I_{GT}	gate trigger current	$V_D = 6 V$	$T_{VJ} = 25^{\circ}C$		150	mA	
			$T_{VJ} = -40^{\circ}C$		200	mA	
V_{GD}	gate non-trigger voltage	$V_D = \frac{2}{3} V_{DRM}$	$T_{VJ} = 125^{\circ}C$		0,2	V	
I_{GD}	gate non-trigger current				10	mA	
I_L	latching current	$t_p = 30 \mu s$	$T_{VJ} = 25^{\circ}C$		300	mA	
		$I_G = 0,5A; di_G/dt = 0,5 A/\mu s$					
I_H	holding current	$V_D = 6 V \quad R_{GK} = \infty$	$T_{VJ} = 25^{\circ}C$		200	mA	
t_{gd}	gate controlled delay time	$V_D = \frac{1}{2} V_{DRM}$	$T_{VJ} = 25^{\circ}C$		2	μs	
		$I_G = 0,5A; di_G/dt = 0,5 A/\mu s$					
t_q	turn-off time	$V_R = 100 V; I_T = 200A; V_D = \frac{2}{3} V_{DRM}$ $di/dt = 10 A/\mu s; dv/dt = 20 V/\mu s; t_p = 200 \mu s$	$T_{VJ} = 125^{\circ}C$		150	μs	



Package Y4				Ratings			
Symbol	Definition	Conditions	min.	typ.	max.	Unit	
I_{RMS}	RMS current	per terminal			300	A	
T_{VJ}	virtual junction temperature		-40		140	°C	
T_{op}	operation temperature		-40		125	°C	
T_{stg}	storage temperature		-40		125	°C	
Weight					131	g	
M_D	mounting torque		2,25		2,75	Nm	
M_T	terminal torque		4,5		5,5	Nm	
$d_{Spp/APP}$	creepage distance on surface striking distance through air	terminal to terminal	14,0	10,0		mm	
$d_{Spb/APb}$		terminal to backside	16,0	16,0		mm	
V_{ISOL}	isolation voltage	t = 1 second	50/60 Hz, RMS; $I_{ISOL} \leq 1$ mA	4800		V	
		t = 1 minute		4000		V	



Data Matrix: part no. (1-19), DC + PI (20-25), lot.no.# (26-31), blank (32), serial no.# (33-36)

Part description

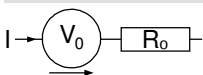
- M = Module
- C = Thyristor (SCR)
- M = Thyristor
- A = (up to 1800V)
- 200 = Current Rating [A]
- PD = Phase leg
- 1800 = Reverse Voltage [V]
- YB = Y4-M6

Ordering	Ordering Number	Marking on Product	Delivery Mode	Quantity	Code No.
Standard	MCMA200PD1800YB	MCMA200PD1800YB	Box	6	

Equivalent Circuits for Simulation

* on die level

$T_{VJ} = 140^{\circ}C$

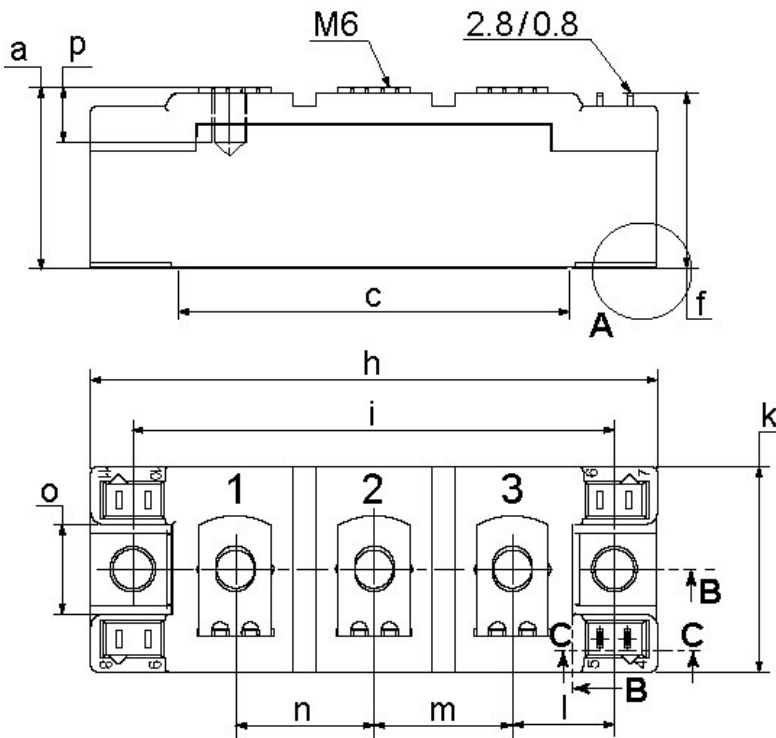


Thyristor

$V_{0\ max}$	threshold voltage	0,83	V
$R_{0\ max}$	slope resistance *	0,8	mΩ



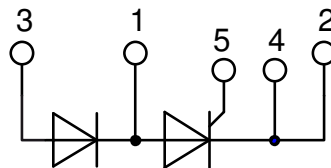
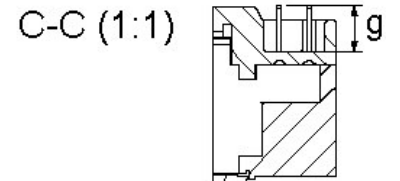
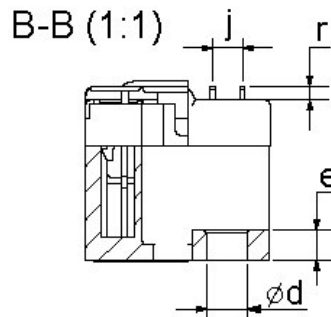
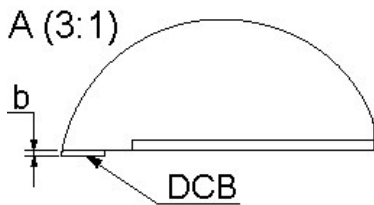
Outlines Y4



Dim.	MIN [mm]	MAX [mm]	MIN [inch]	MAX [inch]
a	30.0	30.6	1.181	1.205
b	typ. 0.25		typ. 0.010	
c	64.0	65.0	2.520	2.559
d	6.5	7.0	0.256	0.275
e	4.9	5.1	0.193	0.201
f	28.6	29.2	1.126	1.150
g	7.3	7.7	0.287	0.303
h	93.5	94.5	3.681	3.720
i	79.5	80.5	3.130	3.169
j	4.8	5.2	0.189	0.205
k	33.4	34.0	1.315	1.339
l	16.7	17.3	0.657	0.681
m	22.7	23.3	0.894	0.917
n	22.7	23.3	0.894	0.917
o	14.0	15.0	0.551	0.591
p	typ. 10.5		typ. 0.413	
r	1.8	2.4	0.071	0.041

Optional accessories for modules

Keyed gate/cathode twin plugs with wire length = 350 mm, gate = white, cathode = red
Type ZY 180L (L = Left for pin pair 4/5) UL 758, style 3751



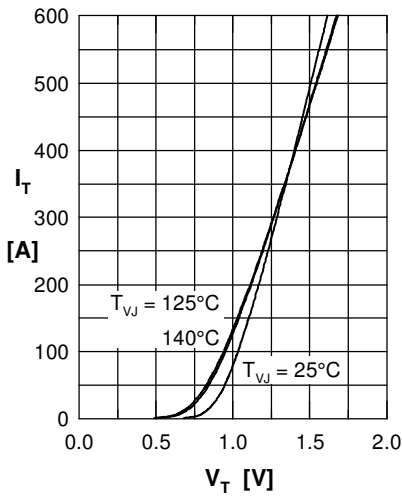
Thyristor


Fig. 1 Forward current vs. voltage drop per thyristor

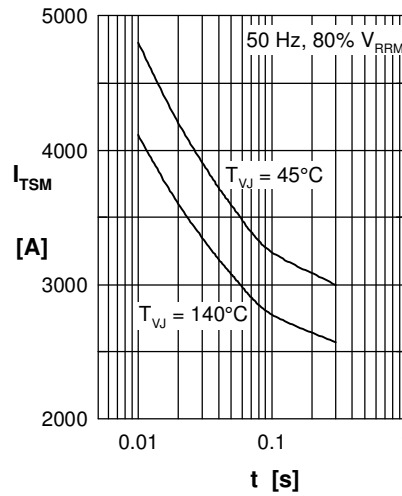


Fig. 2 Surge overload current vs. time per thyristor

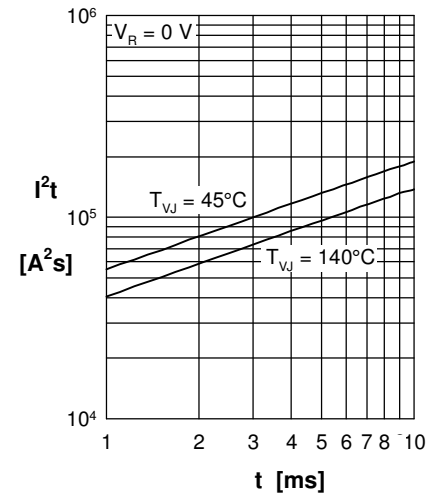
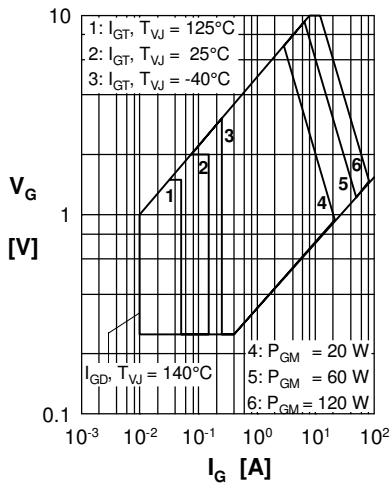

 Fig. 3 I^2t vs. time per thyristor


Fig. 4 Gate voltage & gate current

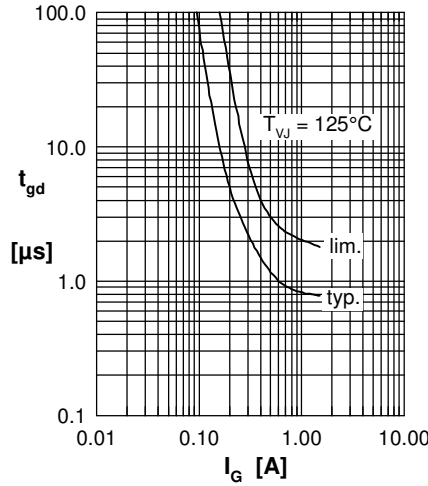
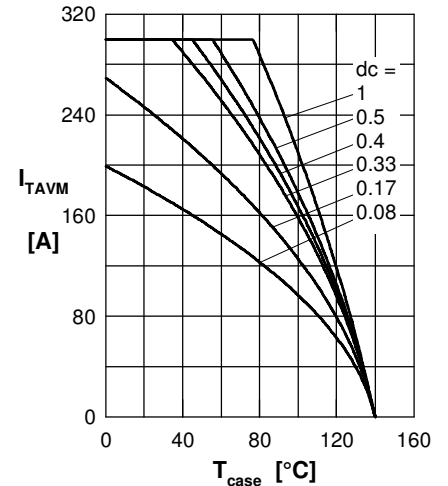

 Fig. 5 Gate controlled delay time t_{gd}


Fig. 6 Max. forward current vs. case temperature per thy.

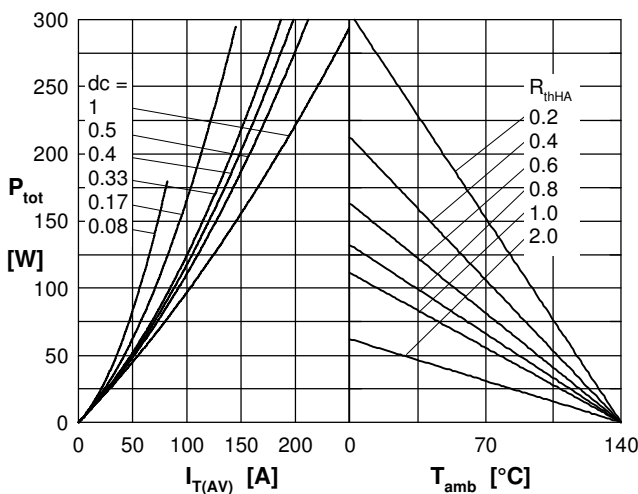


Fig. 7 Power dissipation vs. forward current and ambient temperature per thyristor

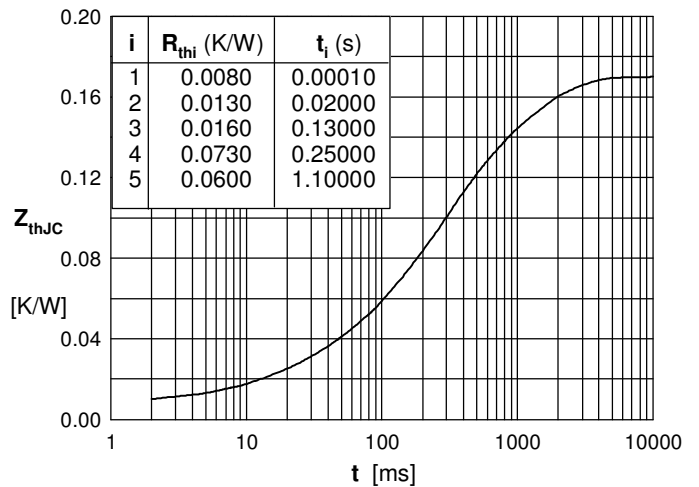


Fig. 8 Transient thermal impedance junction to case vs. time per thyristor