

Evaluation Board for Motor Driver, Single-phase, PWM, Full-wave, BLDC Motor

Overview

This evaluation board is designed to provide an easy and quick development platform for single-phase BLDC motor control applications, using the following devices.

- LV88551, LV88561, LV88563

These devices have the closed loop controller for motor rotation speed. And, potentiometers are provided on this board to configure the minimum/maximum target speed, the speed curve against the input PWM duty cycle, and some other parameters/options. The potentiometers might be useful for tuning these parameters and options, otherwise fixed resistors must be removed and re-soldered.

Setting with fixed resistors is also applicable by disconnecting the potentiometers.

Quick start

The evaluation board is programmed to work standalone without PC. The following operation allows the operation of most motors with the default parameters that are preloaded into the device.

- step 1. Connect a motor to J3
- step 2. Connect PWM signal to the pin labeled 'PWM'
- step 3. Connect a power supply to J4 (J5 is provided optionally for low power application less than 4A).
- step 4. Turn on power supply



ON Semiconductor®

www.onsemi.com

USER GUIDE

LV88551JAGEVB
LV88551RGEVB
LV88561JAGEVB
LV88561RGEVB
LV88563JAGEVB

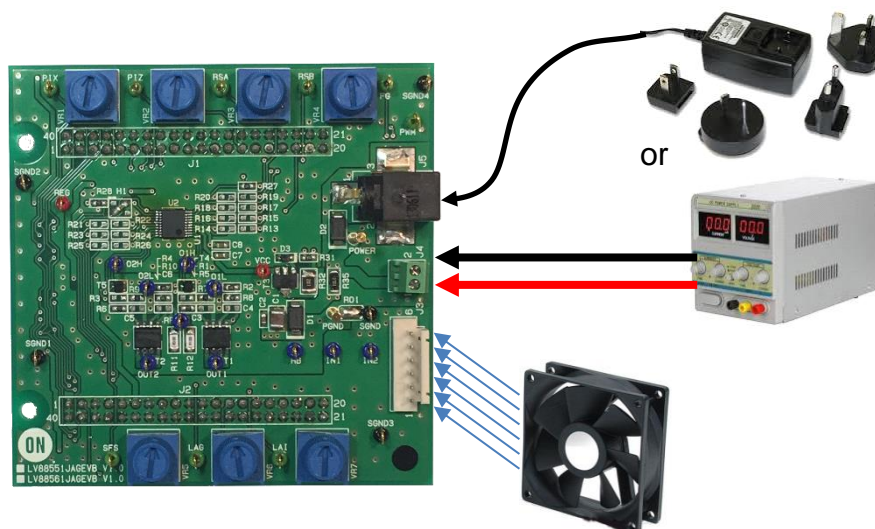

The information herein is subject to be change without notice.

Register Configurable Single-phase Motor Driver Evaluation Kit

HARDWARE DESCRIPTION

Name and Function

1.	Evaluation board	The main board
2.	Connector J4	Main power connector
3.	Connector J5	Optional power jack
4.	Connector J3	Motor windings and signals related Hall
5.	Pin PWM	PWM input
6.	Pin FG	FG output
7.	IC U1 (or U2)	A dial to tweak the command PWM duty cycle for speed control
8.	FETs T1 and T2	Output power FET arrays

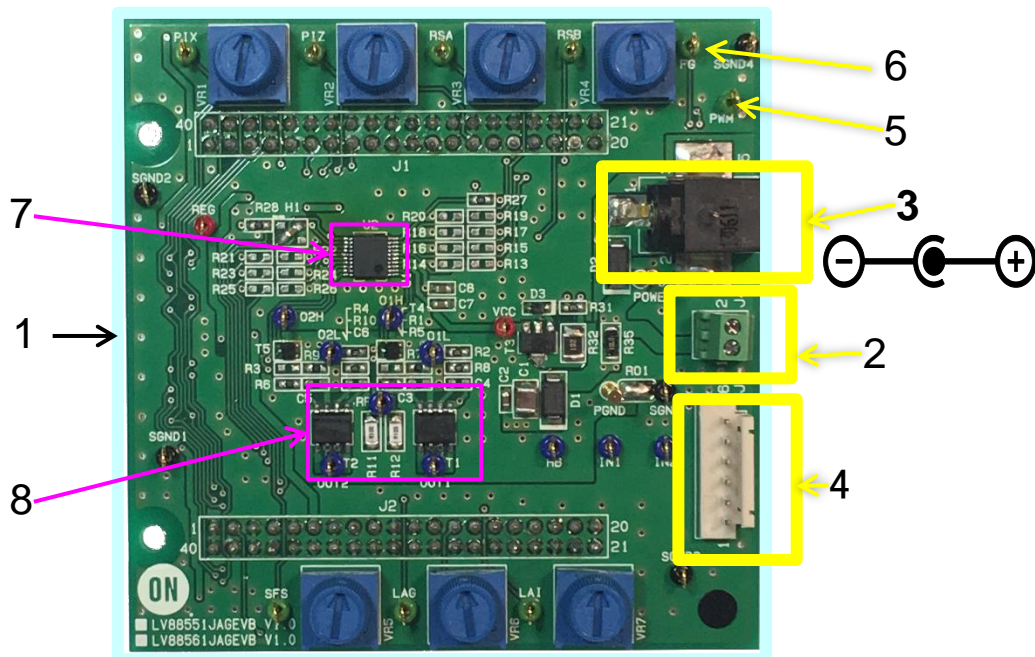

Figure 1 Connectors and key parts

Power supply

J4 is the main power supply connector. The outputs of a power supplier will be connected to this connector. For LV88551EVB, the POWER pin voltage accepts up to 18V. However, for LV88561EVB and LV88563EVB, POWER pin for the operation is from 24V to 48V.



Figure 2 Main power

J5 is an optional connector for a power supply. Low power is assumed (less than 4A).

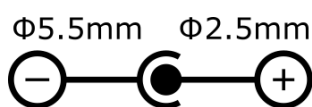

Figure 3 Power Connector Polarity

Motor

J3 is the motor connector.

Pin #	silk label	connected to
1	OUT2	motor winding 2
2	OUT1	motor winding 1
3	IN2	Hall signal +
4	IN1	Hall signal -
5	GND	Ground
6	HB	Hall bias

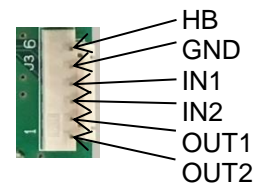

Figure 4 J3 Motor Connector

Register Configurable Single-phase Motor Driver Evaluation Kit

Hall sensor or Hall IC

These devices need a Hall sensor or Hall IC to detect the commutation timing. IN1 and IN2 pins are Hall signal

input pins. This EVB has Hall sensor and in this case, the resistor R38-R40 should be "OPEN". However, in case of using Hall IC, they should be 10kohm.

Parameter setting

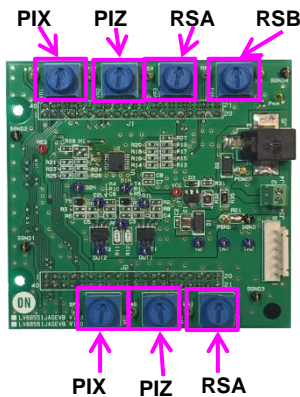

This EVB can use for evaluation at stand-alone state. The AD converter parameters (assigned to the pins; RSA, RSB, PIX, PIZ, LAI, LAG, SFS), can be set by either analog potentiometers or register dividers.

The following table shows resistor and jumper setting combination.

Setting pin	Resistor and jumper	Potentiometer	Fixed resistor divider	Digital potentiometer IC*1
PIX	R13	Open	Resistor	Open
	R14	Open	Resistor	Open
	RO2	Short	Open	Open
	RO4	Open	Open	Short
PIZ	R15	Open	Resistor	Open
	R16	Open	Resistor	Open
	RO5	Short	Open	Open
	RO7	Open	Open	Short
RSA	R17	Open	Resistor	Open
	R18	Open	Resistor	Open
	RO8	Short	Open	Open
	RO9	Open	Open	Short
RSB	R19	Open	Resistor	Open
	R20	Open	Resistor	Open
	RO10	Short	Open	Open
	RO12	Open	Open	Short
SFS	R21	Open	Resistor	Open
	R22	Open	Resistor	Open
	RO13	Short	Open	Open
	RO14	Open	Open	Short
LAG	R23	Open	Resistor	Open
	R24	Open	Resistor	Open
	RO15	Short	Open	Open
	RO17	Open	Open	Short
LAI	R25	Open	Resistor	Open
	R26	Open	Resistor	Open
	RO18	Short	Open	Open
	RO20	Open	Open	Short

*1: not supported in this version

*2: RO3, RO6, RO11, RO16 and RO19 are for "ON INTERNAL USE", and are kept "Open".

Register Configurable Single-phase Motor Driver Evaluation Kit

TYPICAL OPERATION

Overall tuning procedure

1. setup fan, power supply, pulse generator (for PWM duty cycle input)
2. set setting pin voltage with either potentiometer or resistor pair
3. Turn-on power supply
4. Evaluate motor
5. Repeat from step 2, until appropriate evaluation result obtained

The configuration is loaded right after power-on from off. Therefore, power off/on cycle is required every time the parameters are changed.

Waveform example

Below is the example waveform of LV88561JA with various Lead Angle Settings.

The EVB condition is;

- VIN=48V
- 2000RPM setting (PWM=100%)

Lead Angle setting (LAG ; 0 deg., LAI ; 0 deg.)

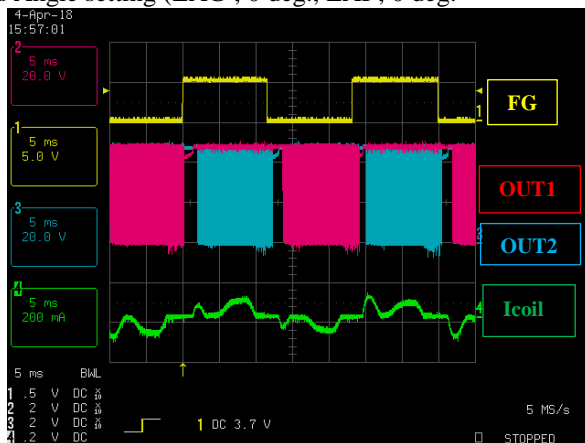

Lead Angle setting (LAG ; +9.975deg., LAI ; 0 deg.)

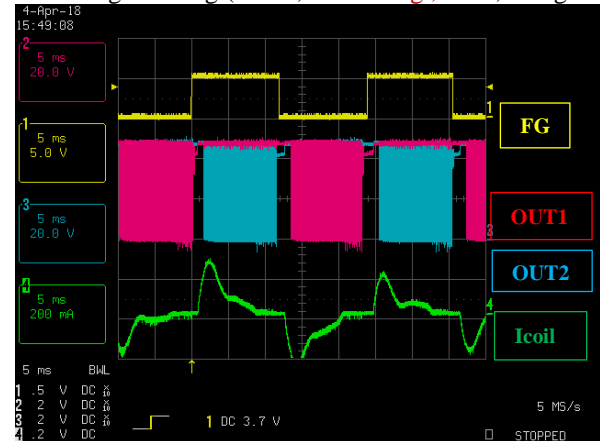

Lead Angle setting (LAG ; -9.975deg., LAI ; 0 deg.)

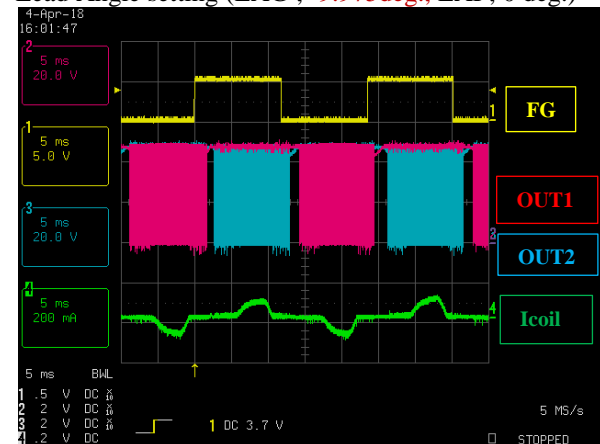

Register Configurable Single-phase Motor Driver Evaluation Kit

APPENDIX A SCHEMATIC

LV88551JA/R, LV88561JA/R, LV88563JA/R_GEVB V1.0 SCHEMATIC

2018/04/06

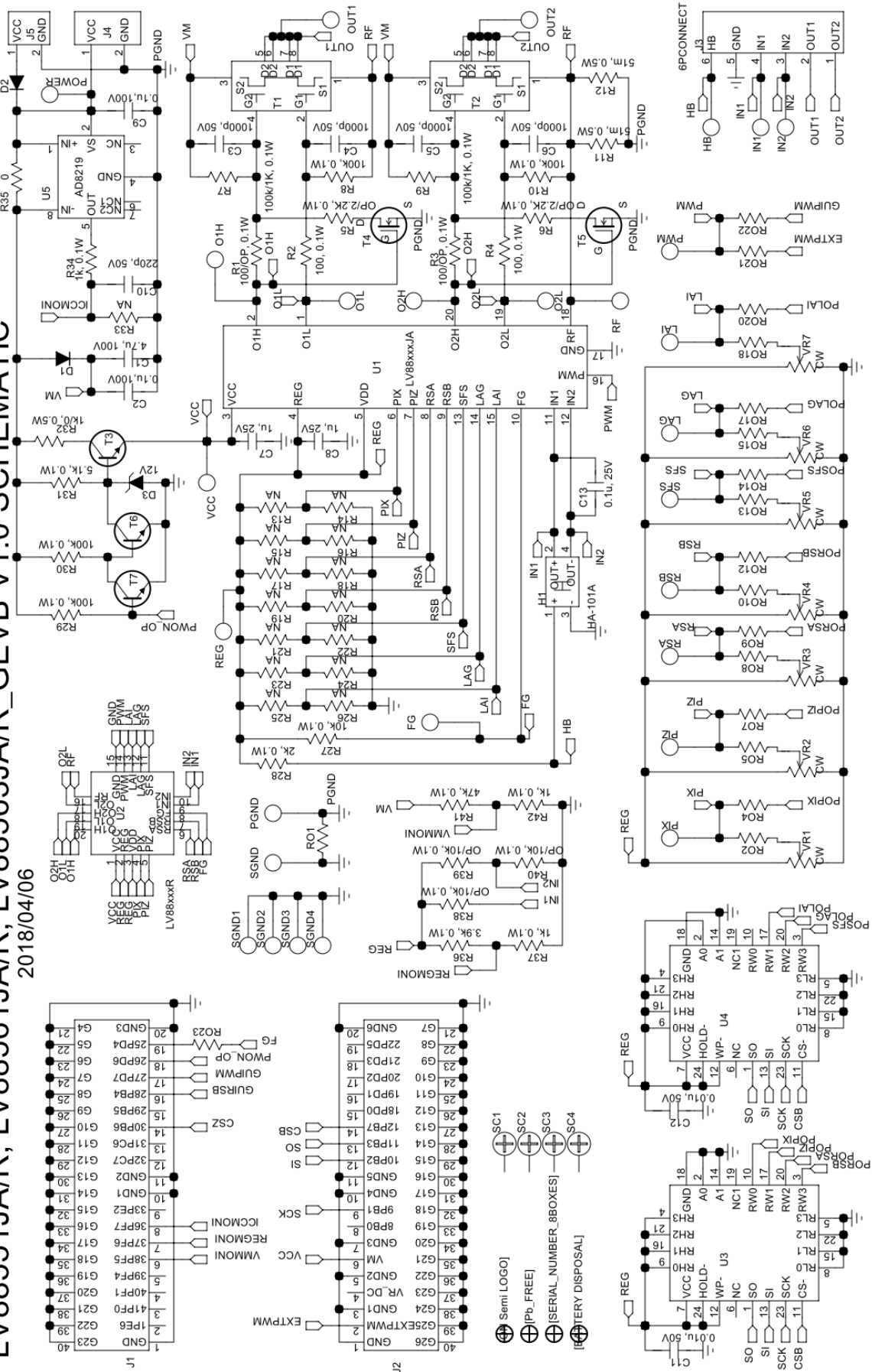

Register Configurable Single-phase Motor Driver Evaluation Kit

APPENDIX B BOM LIST

Bill of Materials for the LV88551JA/R_GEBV Evaluation Board V1.0

Designator	QTY.	Description	Value	Tolerance	Footprint	Manufacturer	Part Number	Substitution Allowed	Lead Free
U1	1	Pre-driver for a single-phase BLDC motor			SSOP20J	ON Semiconductor	LV88551JA	No	Yes
U2	1	Pre-driver for a single-phase BLDC motor	No installed		VCT20 3x3	ON Semiconductor	LV88551R	No	Yes
U3-4	2	Potentiometer	100k		TSSOP-24	ON Semiconductor	CAT5251Y100	Yes	Yes
U5	1	Current shunt monitor	No installed		MSOP8	ANALOG DEVICES	AD8219BRMZ	Yes	Yes
T1-2	2	Complementary dual power MOSFET			SOIC8	ON Semiconductor	FW4604-TL-2W (30V, 6A)	Yes	Yes
T3	1	NPN Transistor			PCP	ON Semiconductor	2SC3646T-TD-E	Yes	Yes
T4-5	2	NCH MOSFET	No installed		SOT-323	ON Semiconductor	MCH3486-TL-W	Yes	Yes
T6-7	2	NPN Transistor			SOT-23	ON Semiconductor	BC846ALT1G	Yes	Yes
D1-2	2	Schottky diode			SMA	ON Semiconductor	MBRA340T3G	Yes	Yes
D3	1	ZENER-DIODE	12V		SOD-323	ON Semiconductor	MM3Z12VT1G	Yes	Yes
RO1	1	Solder JP			4030			Yes	Yes
RO2-23	22	Solder JP			3010			Yes	Yes
RO2 RO5 RO8 RO10 RO13 RO15 RO18	7	Solder JP	short					Yes	
VR1-7	7	Potentiometer			10x10mm	SUNTAN	TSR-3386K104R	Yes	Yes
H1	1	Hall element			4-SOP	ASAHI KASEI	HW-101A	Yes	Yes
J1	1	Pin Socket 20			Pitch 2.54mm	Useconn	FH-2x20SG	Yes	Yes
J2	1	Pin Socket 20			Pitch 2.54mm	Useconn	FH-2x20SG	Yes	Yes
J3	1	Motor connector			Pitch 2.54mm	HIROSE Electronics	DF1-6P-2.5DSA(05)	Yes	Yes
J4	1	Power supply connector			Pitch 2.54mm	Tyco Electronics	282834-2	Yes	Yes
J5	1	AC-DC adapter connector				Singatron	2DC-0415D200	Yes	Yes
C1	1	Capacitor	4.7u, 100V	±10%	3225 BIG	MURATA	GRM32DC72A475K	Yes	Yes
C2 C9	2	Capacitor	0.1u,100V	±10%	1608 BIG	MURATA	GRM188R72A104K	Yes	Yes
C3-6	4	Capacitor	1000p, 50V	±10%	1608 BIG	MURATA	GRM188B11H102K	Yes	Yes
C7-8	2	Capacitor	1u, 25V	±10%	1608 BIG	MURATA	GRM188B31E105K	Yes	Yes
C10	1	Capacitor	220p, 50V		1608 BIG	MURATA	GRM188B11H221K	Yes	Yes
C11-12	2	Capacitor	0.01u, 50V	±10%	1608 BIG	MURATA	GRM188B11H103K	Yes	Yes
C13	1	Capacitor	0.1u,25V	±10%	1608 BIG	MURATA	GRM188B11E104K	Yes	Yes
R1 R3	2	Resistor	100, 0.1W	±5%	1608 BIG	KOA	RK73B1JTxxxJ	Yes	Yes
R2 R4	2	Resistor	100, 0.1W	±5%	1608 BIG	KOA	RK73B1JTxxxJ	Yes	Yes
R5-6	2	Resistor	No installed		1608 BIG	KOA	RK73B1JTxxxJ	Yes	Yes
R7 R9	2	Resistor	100k, 0.1W	±5%	1608 BIG	KOA	RK73B1JTxxxJ	Yes	Yes
R8 R10 R29-30	4	Resistor	100k, 0.1W	±5%	1608 BIG	KOA	RK73B1JTxxxJ	Yes	Yes
R11-12	2	Resistor	51m, 0.5W	±1%	3216 BIG	Rohm	UCR18EVHFSR051	Yes	Yes
R13-26	14	Resistor	No installed		1608 BIG	KOA	RK73B1JTxxxJ	Yes	Yes
R27	1	Resistor	10k, 0.1W	±5%	1608 BIG	KOA	RK73B1JTxxxJ	Yes	Yes
R28	1	Resistor	2k, 0.1W	±5%	1608 BIG	KOA	RK73B1JTxxxJ	Yes	Yes
R31	1	Resistor	5.1k, 0.1W	±5%	1608 BIG	KOA	RK73B1JTxxxJ	Yes	Yes
R32	1	Resistor	0					Yes	Yes
R33	1	Resistor	No installed		1608 BIG	KOA	RK73B1JTxxxJ	Yes	Yes
R34 R37 R42	3	Resistor	1k, 0.1W	±5%	1608 BIG	KOA	RK73B1JTxxxJ	Yes	Yes
R35	1	Resistor	0					Yes	Yes
R36	1	Resistor	3.9k, 0.1W	±5%	1608 BIG	KOA	RK73B1JTxxxJ	Yes	Yes
R38-40	3	Resistor	OPEN		1608 BIG	KOA	RK73B1JTxxxJ	Yes	Yes
R41	1	Resistor	47k, 0.1W	±5%	1608 BIG	KOA	RK73B1JTxxxJ	Yes	Yes

Register Configurable Single-phase Motor Driver Evaluation Kit

Bill of Materials for the LV88561JA/R and LV88563JA_GEVB Evaluation Board V1.0

Designator	QTY.	Description	Value	Tolerance	Footprint	Manufacturer	Part Number	Substitution Allowed	Lead Free
U1	1	Pre-driver for a single-phase BLDC motor			SSOP20J	ON Semiconductor	LV88561 / 563JA	No	Yes
U2	1	Pre-driver for a single-phase BLDC motor	No Installed		VCT20 3x3	ON Semiconductor	LV88561 / 563R	No	Yes
U3-4	2	Potentiometer	100k		TSSOP-24	ON Semiconductor	CAT5251Y100	Yes	Yes
U5	1	Current shunt monitor	No Installed		MSOP8	ANALOG DEVICES	AD8219BRMZ	Yes	Yes
T1-2	2	Complementary dual power MOSFET			SOIC8	ON Semiconductor	FW389-TL-2W (100V, 2A)	Yes	Yes
T3	1	NPN Transistor			PCP	ON Semiconductor	2SC3646T-TD-E	Yes	Yes
T4-5	2	NCH MOSFET			SOT-323	ON Semiconductor	MCH3486-TL-W	Yes	Yes
T6-7	2	NPN Transistor			SOT-23	ON Semiconductor	BC846ALT1G	Yes	Yes
D1-2	2	Schottky diode			SMA	ON Semiconductor	MBRA340T3G	Yes	Yes
D3	1	ZENER-DIODE	12V		SOD-323	ON Semiconductor	MM3Z12VT1G	Yes	Yes
RO1	1	Solder JP			4030			Yes	Yes
RO2-23	22	Solder JP			3010			Yes	Yes
RO2 RO5 RO8 RO10 RO13 RO15 RO18	7	Solder JP	short					Yes	
VR1-7	7	Potentiometer			10x10mm	SUNTAN	TSR-3386K104R	Yes	Yes
H1	1	Hall element			4-SOP	ASAHI KASEI	HW-101A	Yes	Yes
J1	1	Pin Socket 20			Pitch 2.54mm	Useconn	FH-2x20SG	Yes	Yes
J2	1	Pin Socket 20			Pitch 2.54mm	Useconn	FH-2x20SG	Yes	Yes
J3	1	Motor connector			Pitch 2.54mm	HIROSE Electronics	DF1-6P-2.5DSA(05)	Yes	Yes
J4	1	Power supply connector			Pitch 2.54mm	Tyco Electronics	282834-2	Yes	Yes
J5	1	AC-DC adapter connector				Singatron	2DC-0415D200	Yes	Yes
C1	1	Capacitor	4.7u, 100V	±10%	3225 BIG	MURATA	GRM32DC72A475K	Yes	Yes
C2 C9	2	Capacitor	0.1u, 100V	±10%	1608 BIG	MURATA	GRM188R72A104K	Yes	Yes
C3-6	4	Capacitor	1000p, 50V	±10%	1608 BIG	MURATA	GRM188B11H102K	Yes	Yes
C7-8	2	Capacitor	1u, 25V	±10%	1608 BIG	MURATA	GRM188B31E105K	Yes	Yes
C10	1	Capacitor	220p, 50V	±10%	1608 BIG	MURATA	GRM188B11H221K	Yes	Yes
C11-12	2	Capacitor	0.01u, 50V	±10%	1608 BIG	MURATA	GRM188B11H103K	Yes	Yes
C13	1	Capacitor	0.1u, 25V	±10%	1608 BIG	MURATA	GRM188B11E104K	Yes	Yes
R1 R3	2	Resistor	OPEN		1608 BIG	KOA	RK73B1JTxxxJ	Yes	Yes
R2 R4	2	Resistor	100, 0.1W	±5%	1608 BIG	KOA	RK73B1JTxxxJ	Yes	Yes
R5-6	2	Resistor	2.2k, 0.1W	±5%	1608 BIG	KOA	RK73B1JTxxxJ	Yes	Yes
R7 R9	2	Resistor	1k, 0.1W	±5%	1608 BIG	KOA	RK73B1JTxxxJ	Yes	Yes
R8 R10 R29-30	4	Resistor	100k, 0.1W	±5%	1608 BIG	KOA	RK73B1JTxxxJ	Yes	Yes
R11-12	2	Resistor	51m, 0.5W	±1%	3216 BIG	Rohm	UCR18EVHFSR051	Yes	Yes
R13-26	14	Resistor	No Installed	±5%	1608 BIG	KOA	RK73B1JTxxxJ	Yes	Yes
R27	1	Resistor	10k, 0.1W	±5%	1608 BIG	KOA	RK73B1JTxxxJ	Yes	Yes
R28	1	Resistor	2k, 0.1W	±5%	1608 BIG	KOA	RK73B1JTxxxJ	Yes	Yes
R31	1	Resistor	5.1k, 0.1W	±5%	1608 BIG	KOA	RK73B1JTxxxJ	Yes	Yes
R32	1	Resistor	1k, 0.5W	±5%	3225 BIG	Rohm	ESR25JZPJ102	Yes	Yes
R33	1	Resistor	No Installed	±5%	1608 BIG	KOA	RK73B1JTxxxJ	Yes	Yes
R34 R37 R42	3	Resistor	1k, 0.1W	±5%	1608 BIG	KOA	RK73B1JTxxxJ	Yes	Yes
R35	1	Resistor	0					Yes	Yes
R36	1	Resistor	3.9k, 0.1W	±5%	1608 BIG	KOA	RK73B1JTxxxJ	Yes	Yes
R38-40	3	Resistor	OPEN		1608 BIG	KOA	RK73B1JTxxxJ	Yes	Yes
R41	1	Resistor	47k, 0.1W	±5%	1608 BIG	KOA	RK73B1JTxxxJ	Yes	Yes