

LOW DROPOUT VOLTAGE REGULATOR

■ GENERAL DESCRIPTION

NJM2881/82 is a low dropout voltage regulator with ON/OFF control.

Advanced Bipolar technology achieves low noise, high ripple rejection and low quiescent current.

It is mounted on SOT-23-5 as small package and 1.0 μ F ceramic capacitor is available. Therefore it is suitable for cellular phone, camcorder, IC decoder, camera, and other portable items.

■ PACKAGE OUTLINE

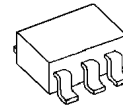

NJM2881/82F

■ FEATURES

- High Ripple Rejection 75dB typ. (f=1kHz, Vo=3V version)
- Low Output Noise Voltage Vno=30 μ Vrms (Cp=0.01 μ F)
- Output capacitor with 1.0 μ F ceramic capacitor (Vo \geq 2.7V)
- Output Current Io(max.)=300mA
- High Precision Output Vo \pm 1.0%
- Low Dropout Voltage 0.10V typ. (Io=100mA)
- ON/OFF Control (Active High)
- Internal Short Circuit Current Limit
- Internal Thermal Overload Protection
- Bipolar Technology
- Package Outline SOT-23-5

■ PIN CONFIGURATION

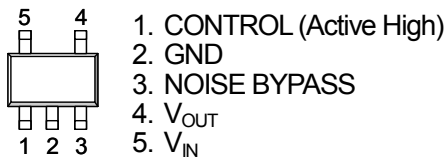

NJM2881F

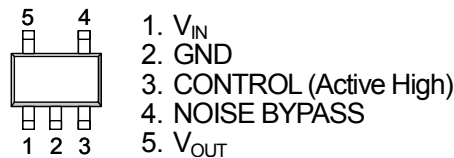

NJM2882F

■ BLOCK DIAGRAM

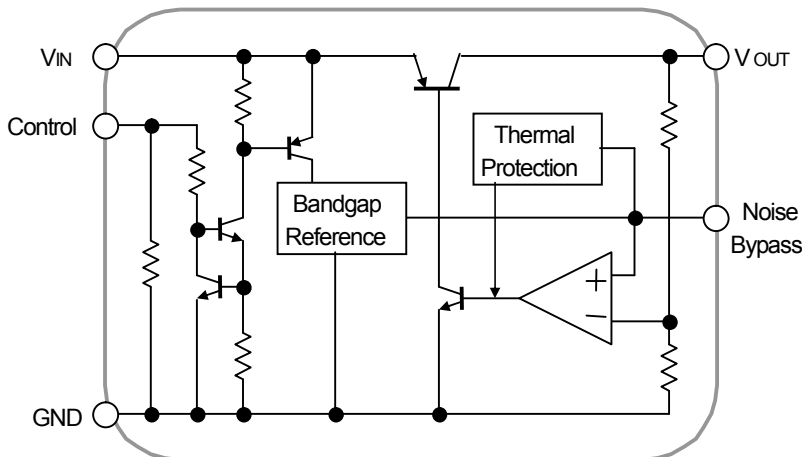

NJM2881/82

■ OUTPUT VOLTAGE RANK LIST

Device Name	V _{OUT}	Device Name	V _{OUT}	Device Name	V _{OUT}
NJM288*F15	1.5V	NJM288*F29	2.9V	NJM288*F38	3.8V
NJM288*F17	1.7V	NJM288*F03	3.0V	NJM288*F04	4.0V
NJM288*F18	1.8V	NJM288*F31	3.1V	NJM288*F43	4.3V
NJM288*F21	2.1V	NJM288*F32	3.2V	NJM288*F47	4.7V
NJM288*F25	2.5V	NJM288*F33	3.3V	NJM288*F05	5.0V
NJM288*F28	2.8V	NJM288*F345	3.45V		
NJM288*F285	2.85V	NJM288*F35	3.5V		

■ ABSOLUTE MAXIMUM RATINGS (Ta=25°C)

PARAMETER	SYMBOL	RATINGS	UNIT
Input Voltage	V _{IN}	+14	V
Control Voltage	V _{CONT}	+14(*1)	V
Power Dissipation	P _D	SOT-23-5 350(*2) 200(*3)	mW
Operating Temperature	Topr	-40 ~ +85	°C
Storage Temperature	Tstg	-40 ~ +125	°C

(*1): When input voltage is less than +14V, the absolute maximum control voltage is equal to the input voltage.

(*2): Mounted on glass epoxy board based on EIA/JEDEC. (114.3x76.2x1.6mm: 2Layers)

(*3): Device itself.

■ Operating voltage

V_{IN}=+2.3 ~ +6V (In case of Vo<2.1V)

■ ELECTRICAL CHARACTERISTICS

(Vo>2.0V version: V_{IN}=Vo+1V, C_{IN}=0.1μF, Co=1.0μF: Vo≥2.7V (Co=2.2μF: Vo≤2.6V), Cp=0.01μF, Ta=25°C)

PARAMETER	SYMBOL	TEST CONDITION	MIN.	TYP.	MAX.	UNIT
Output Voltage	Vo	Io=30mA	-1.0%	-	+1.0%	V
Quiescent Current	I _Q	Io=0mA, except I _{cont}	-	120	180	μA
Quiescent Current at Control OFF	I _{Q(OFF)}	V _{CONT} =0V	-	-	100	nA
Output Current	Io	Vo=0.3V	300	400	-	mA
Line Regulation	ΔVo/ΔV _{IN}	V _{IN} =Vo+1V ~ Vo+6V, Io=30mA	-	-	0.10	%/V
Load Regulation	ΔVo/ΔIo	Io=0 ~ 300mA	-	-	0.03	%/mA
Dropout Voltage	ΔV _{LO}	Io=100mA	-	0.10	0.18	V
Ripple Rejection	RR	e _{in} =200mVrms, f=1kHz, Io=10mA, Vo=3V version	-	75	-	dB
Average Temperature Coefficient of Output Voltage	ΔVo/ΔTa	Ta=0 ~ 85°C, Io=10mA	-	± 50	-	ppm/°C
Output Noise Voltage	V _{NO}	f=10Hz ~ 80kHz, Io=10mA, Vo=3V version	-	30	-	μVrms
Control Voltage for ON-state	V _{CONT(ON)}		1.6	-	-	V
Control Voltage for OFF-state	V _{CONT(OFF)}		-	-	0.6	V

■ ELECTRICAL CHARACTERISTICS

($V_o \leq 2.0V$ version: $V_{IN} = V_o + 1V$, $C_{IN} = 0.1\mu F$, $C_o = 2.2\mu F$; $V_o \geq 1.9V$ ($C_o = 4.7\mu F$: $V_o \leq 1.8V$), $C_p = 0.01\mu F$, $T_a = 25^\circ C$)

PARAMETER	SYMBOL	TEST CONDITION	MIN.	TYP.	MAX.	UNIT
Output Voltage	V_o	$I_o = 30mA$	-1.0%	-	+1.0%	V
Quiescent Current	I_Q	$I_o = 0mA$, except I_{CONT}	-	120	180	μA
Quiescent Current at Control OFF	$I_{Q(OFF)}$	$V_{CONT} = 0V$	-	-	100	nA
Output Current	I_o	$V_o = 0.3V$	300	400	-	mA
Line Regulation	$\Delta V_o / \Delta V_{IN}$	$V_{IN} = V_o + 1V \sim V_o + 6V$, $I_o = 30mA$	-	-	0.10	%/V
Load Regulation	$\Delta V_o / \Delta I_o$	$I_o = 0 \sim 300mA$	-	-	0.03	%/mA
Ripple Rejection	RR	$e_{in} = 200mV_{rms}$, $f = 1kHz$, $I_o = 10mA$, $V_o = 1.8V$ version	-	80	-	dB
Average Temperature Coefficient of Output Voltage	$\Delta V_o / \Delta T_a$	$T_a = 0 \sim 85^\circ C$, $I_o = 10mA$	-	± 50	-	ppm/ $^\circ C$
Output Noise Voltage	V_{NO}	$f = 10Hz \sim 80kHz$, $I_o = 10mA$, $V_o = 1.8V$ version	-	20	-	μV_{rms}
Control Voltage for ON-state	$V_{CONT(ON)}$		1.6	-	-	V
Control Voltage for OFF-state	$V_{CONT(OFF)}$		-	-	0.6	V

The above specification is a common specification for all output voltages.

Therefore, it may be different from the individual specification for a specific output voltage.

■ TEST CIRCUIT

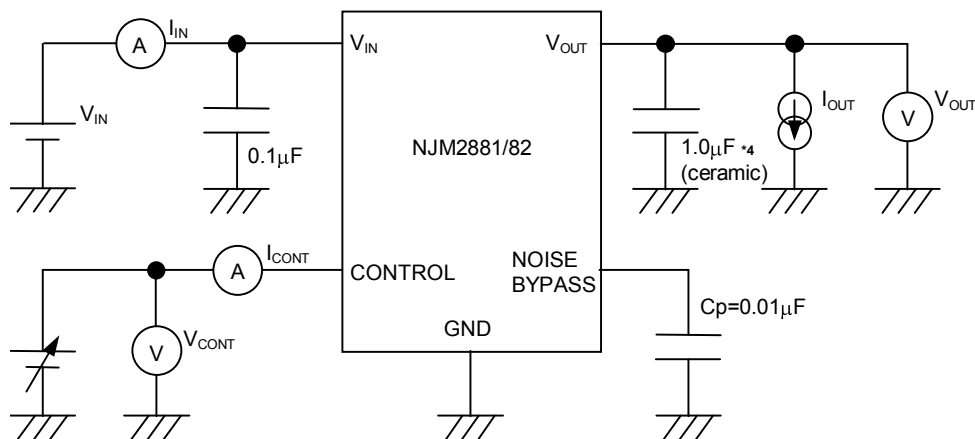

*4 $1.9V \leq V_o \leq 2.6V$ version: $C_o = 2.2\mu F$ (ceramic)
 $V_o \leq 1.8V$ version: $C_o = 4.7\mu F$ (ceramic)

NJM2881/82

■ TYPICAL APPLICATION

① In the case where ON/OFF Control is not required:

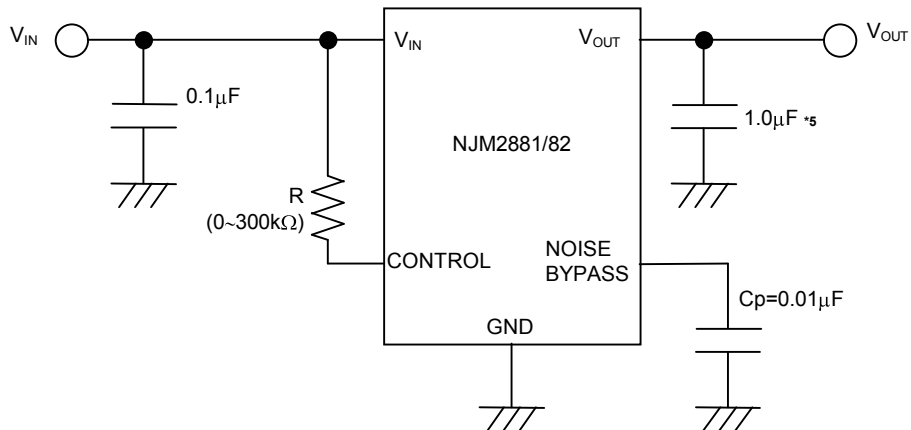

*5 1.9V ≤ Vo ≤ 2.6V version: Co=2.2µF
Vo ≤ 1.8V version: Co=4.7µF

Connect control terminal to V_{IN} terminal

② In use of ON/OFF CONTROL:

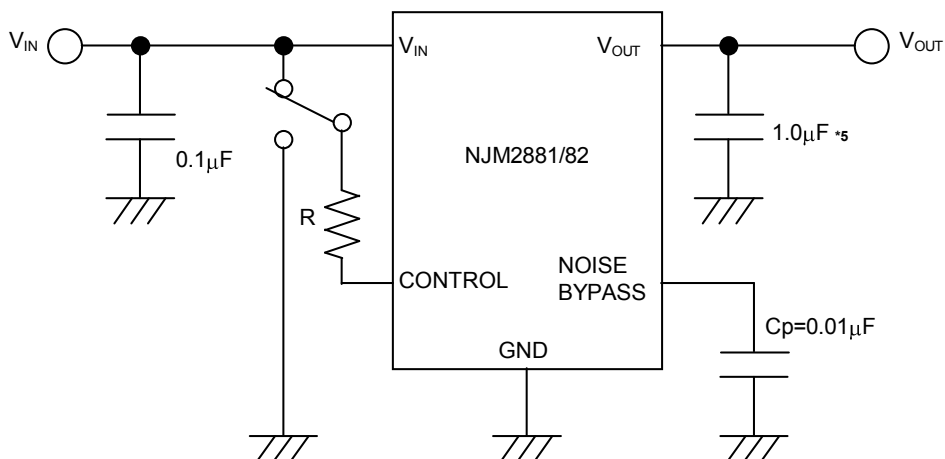

*5 1.9V ≤ Vo ≤ 2.6V version: Co=2.2µF
Vo ≤ 1.8V version: Co=4.7µF

State of control terminal:

- “H” → output is enabled.
- “L” or “open” → output is disabled.

*Noise bypass Capacitance Cp

Noise bypass capacitance Cp reduces noise generated by band-gap reference circuit. Noise level and ripple rejection will be improved when larger Cp is used. Use of smaller Cp value may cause oscillation. Use the Cp value of 0.01µF greater to avoid the problem.

*In the case of using a resistance "R" between V_{IN} and control.

If this resistor is inserted, the control current could be reduced when the control voltage is high.

The applied voltage to control pin should set to consider voltage drop through the resistor “R” and the minimum control voltage for ON-state.

The V_{CONT (ON)} and I_{CONT} have temperature dependence as shown in the "Control Current vs. Temperature" and "Control Voltage vs. Temperature" characteristics. Therefore, the resistor "R" should be selected to consider the temperature characteristics.

*Input Capacitor C_{IN}

The input capacitor C_{IN} is required in order to prevent oscillation and reduce power supply ripple of applications when high power supply impedance or a long power supply line.

Therefore, the recommended capacitance (refer to conditions of ELECTRIC CHARACTERISTIC) or larger input capacitor, connected between V_{IN} and GND as short path as possible, is recommended in order to avoid the problem.

*Output Capacitor C_O

The output capacitor C_O is required for a phase compensation of the internal error amplifier, and the capacitance and the equivalent series resistance (ESR) influence stable operation of the regulator.

If use a smaller output capacitor than the recommended capacitance (refer to conditions of ELECTRIC CHARACTERISTIC), it may cause excess output noise or oscillation of the regulator due to lack of the phase compensation. Therefore, the recommended capacitance or larger output capacitor, connected between V_{OUT} and GND as short path as possible, is recommended for stable operation. The recommended capacitance may be different by output voltage, therefore confirm the recommended capacitance of the required output voltage.

Furthermore, a larger output capacitor reduces output noise and ripple output, and also improves Output Transient Response when a load changes rapidly.

Selecting the output capacitor, should consider varied characteristics of a capacitor: frequency characteristics, temperature characteristics, DC bias characteristics and so on. Therefore, the capacitor that has a sufficient margin of the rated voltage against the output voltage and superior temperature characteristics, is recommended for C_O .

NJM2881/82

POWER DISSIPATION vs. AMBIENT TEMPERATURE

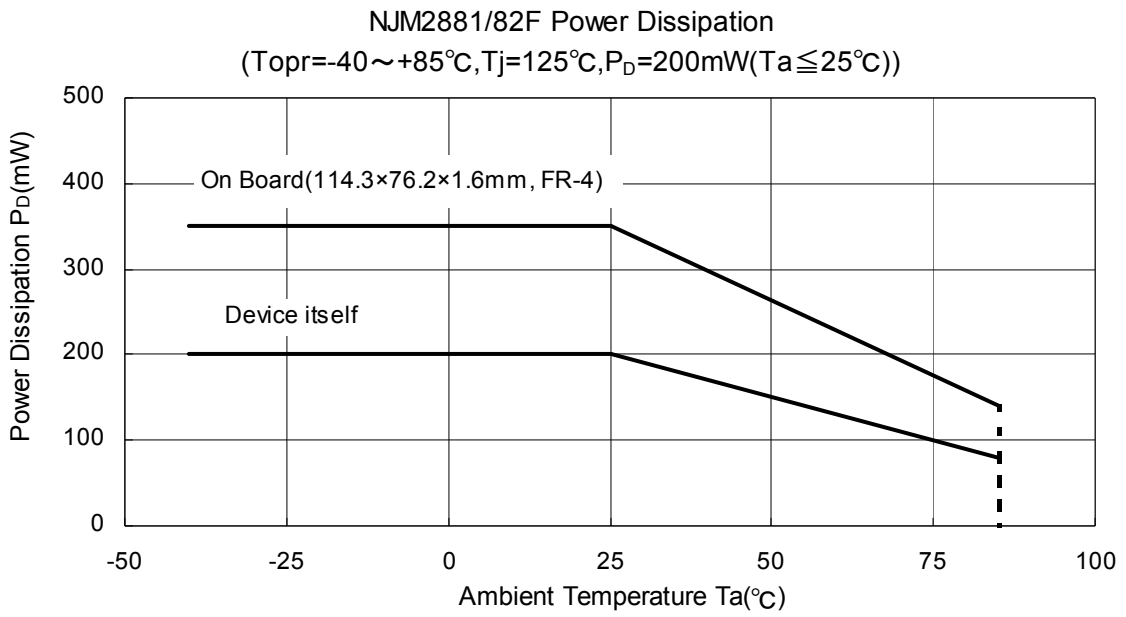

ELECTRICAL CHARACTERISTICS

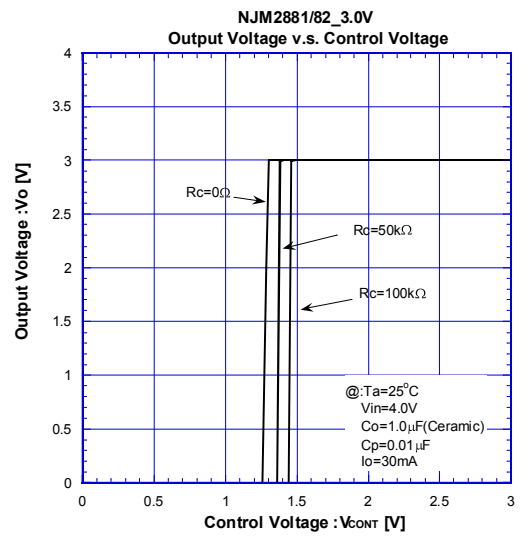
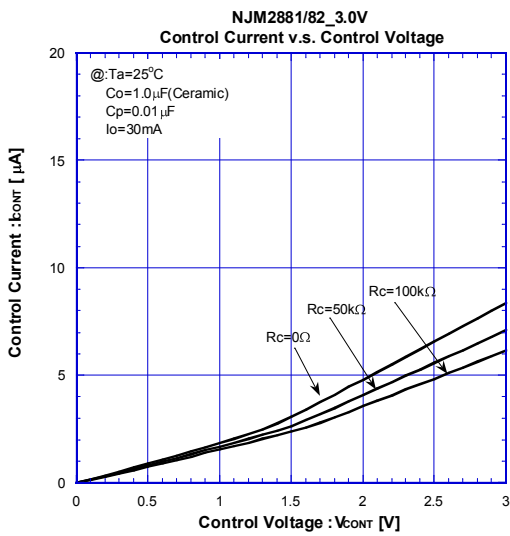
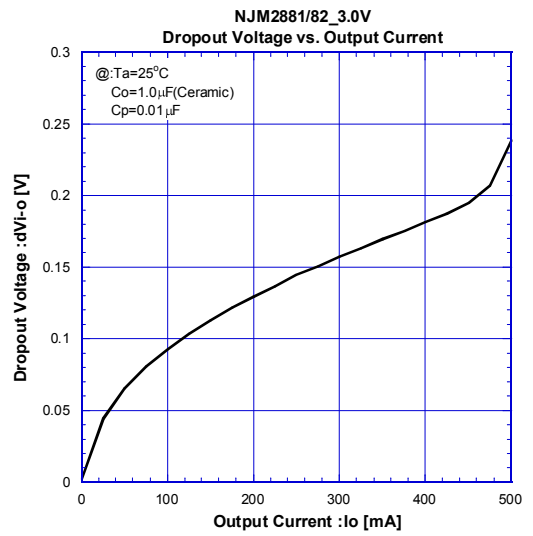
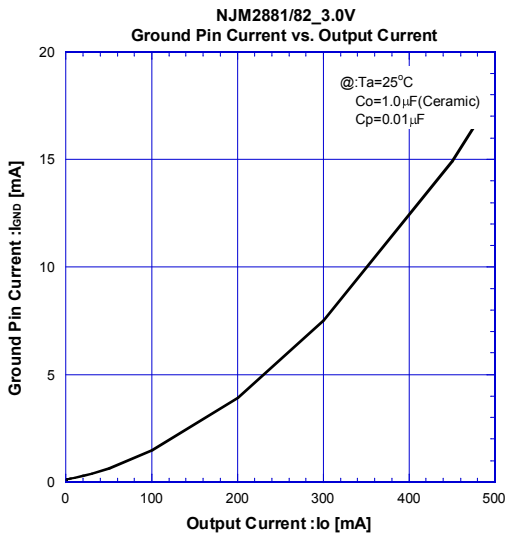
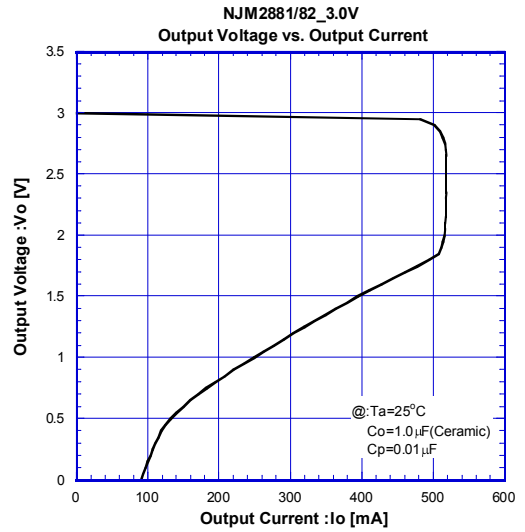
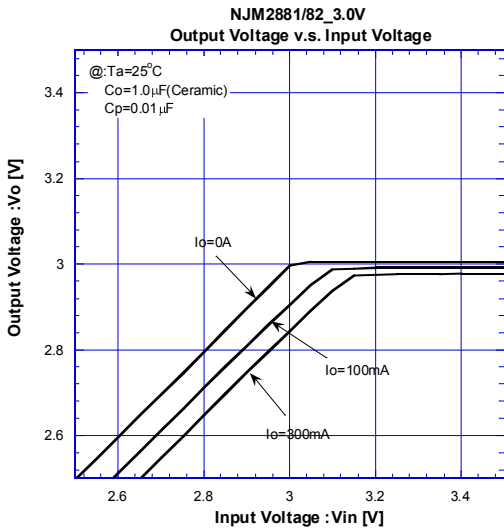

NJM2881/82

ELECTRICAL CHARACTERISTICS

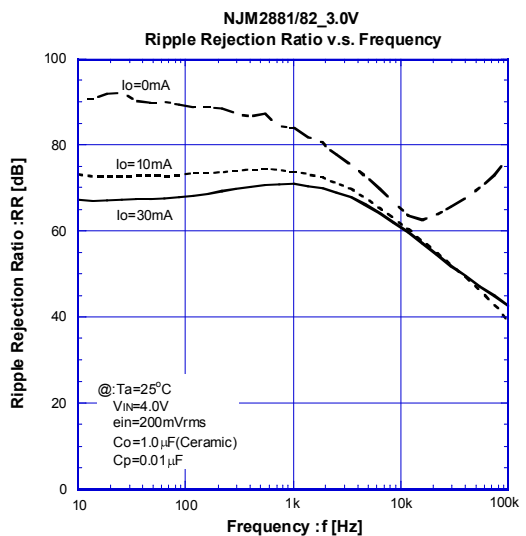
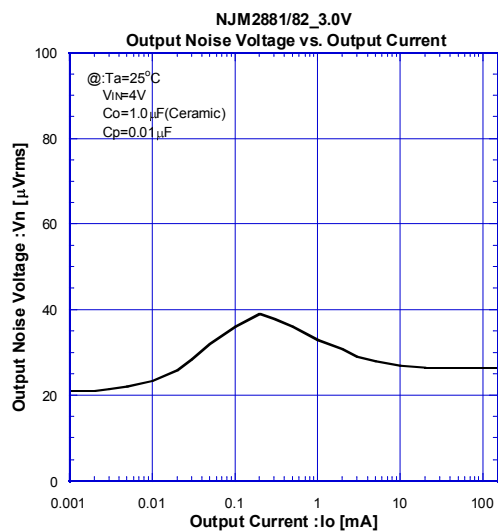
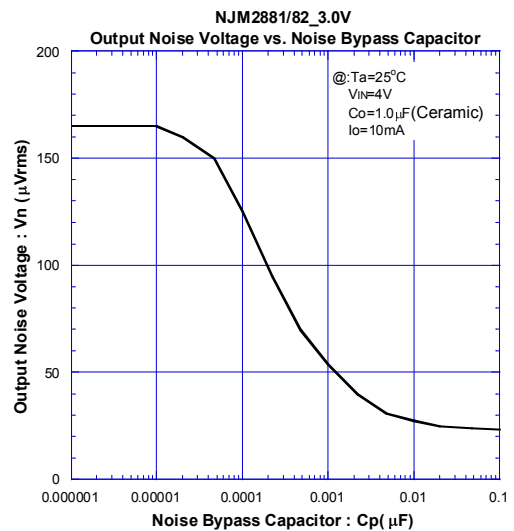
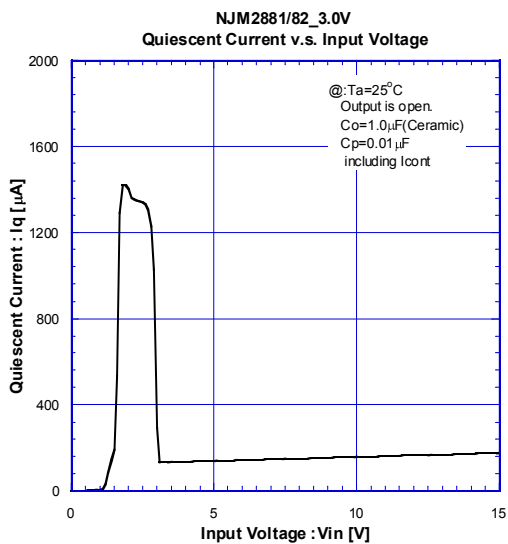
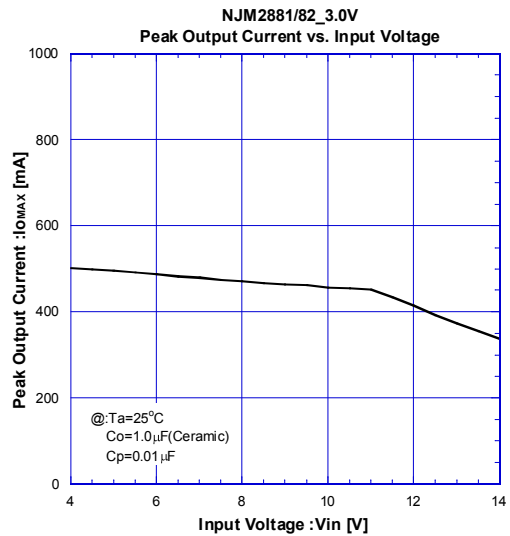
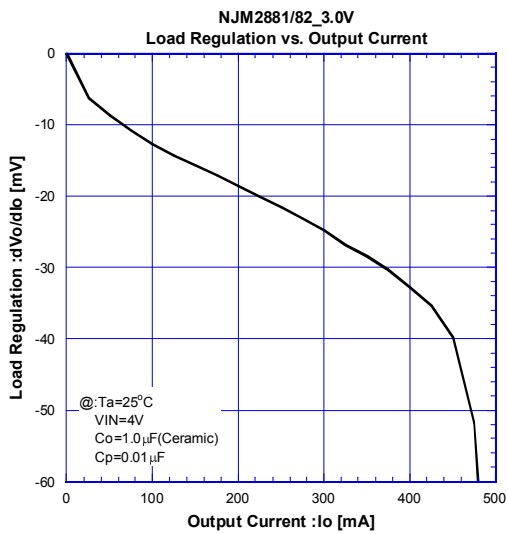

ELECTRICAL CHARACTERISTICS

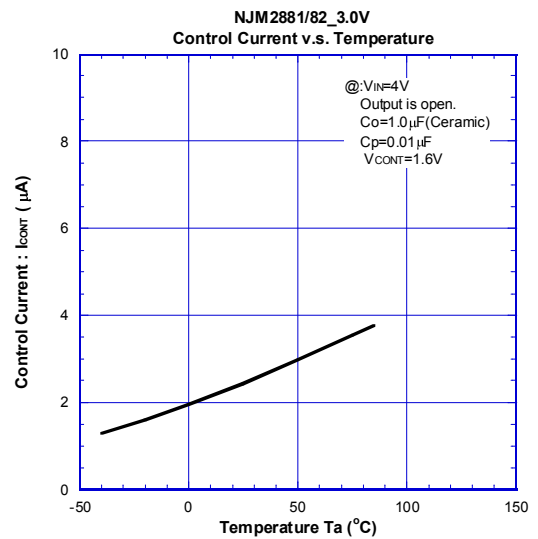
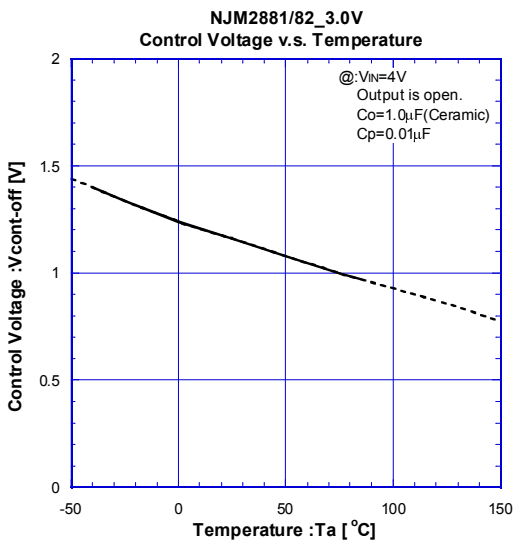
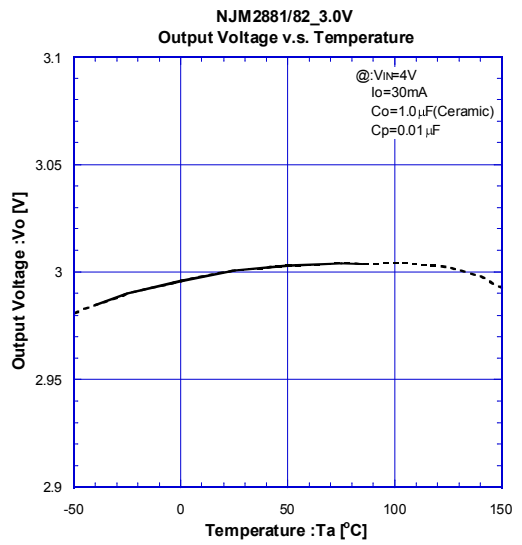
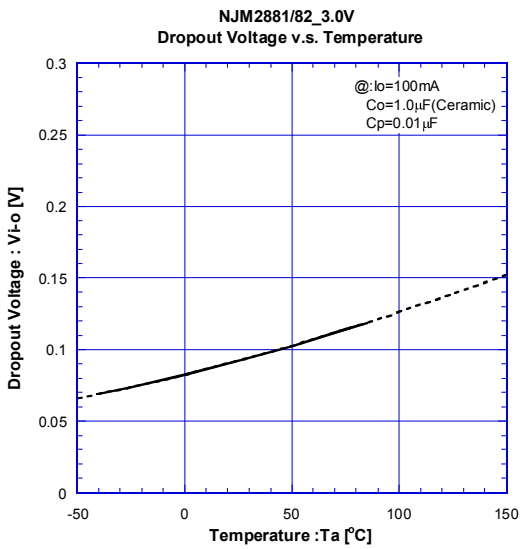
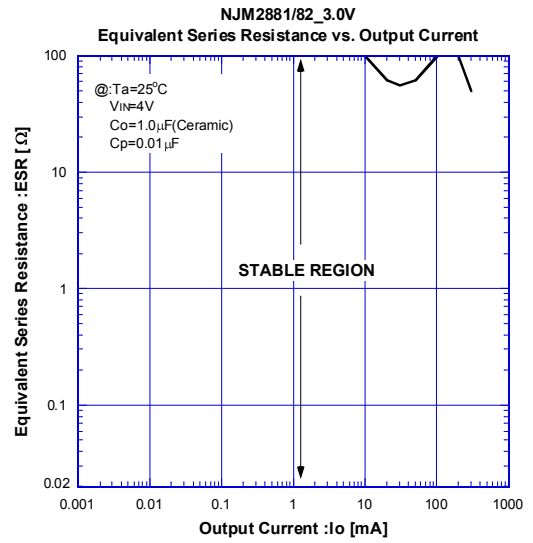
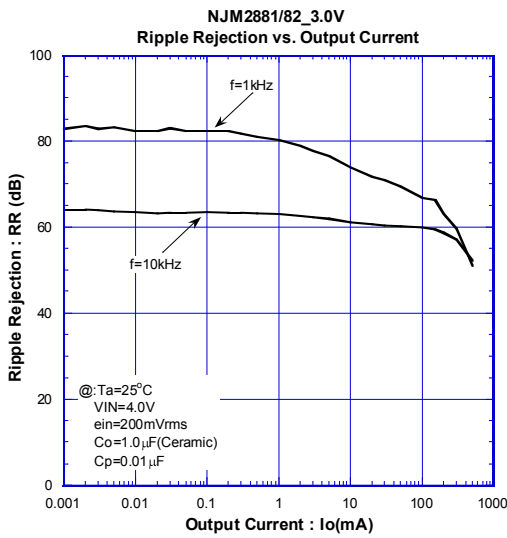

NJM2881/82

ELECTRICAL CHARACTERISTICS

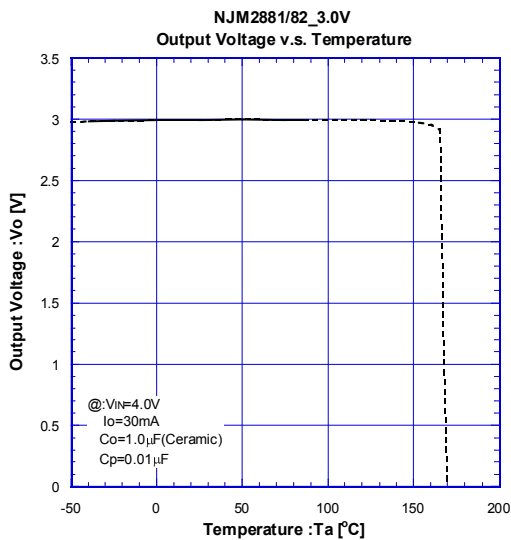
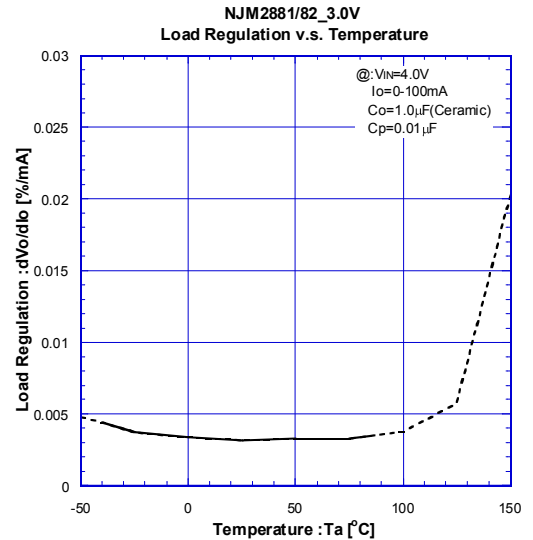
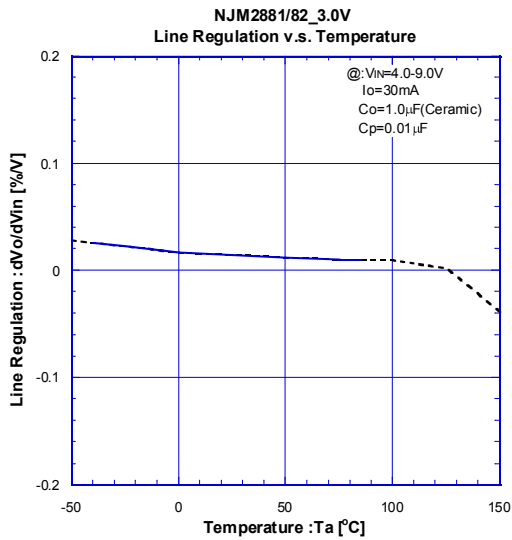
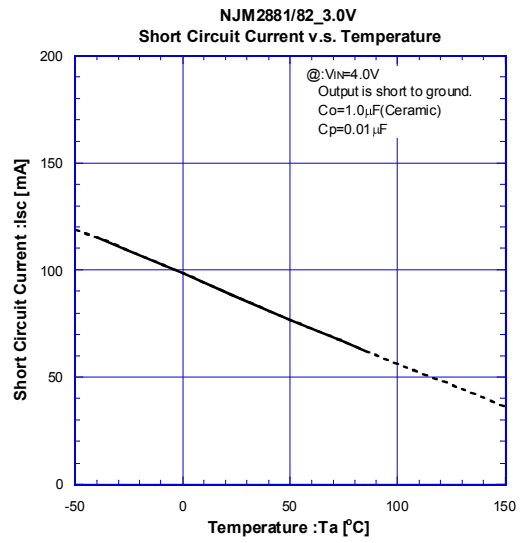
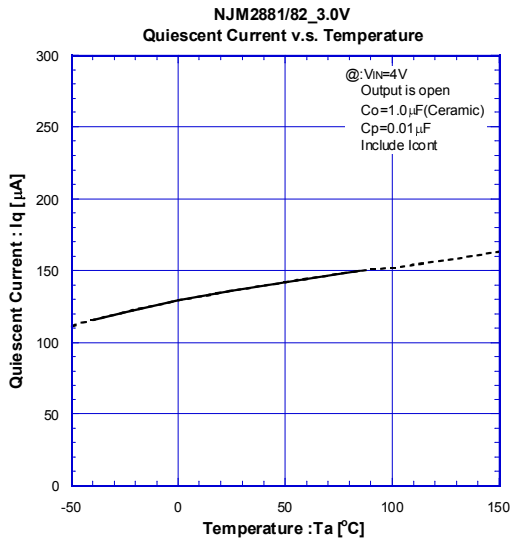

ELECTRICAL CHARACTERISTICS

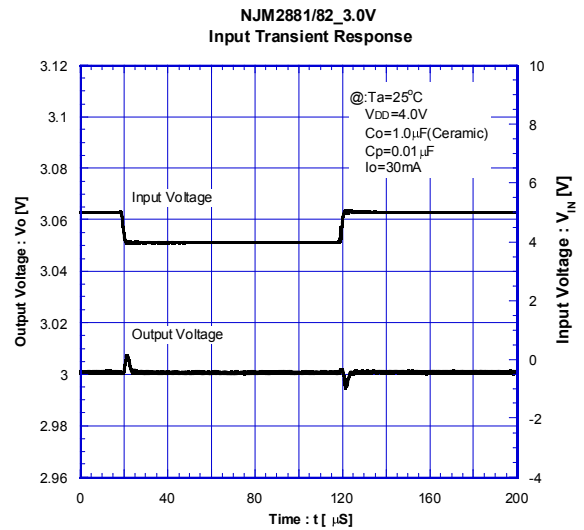
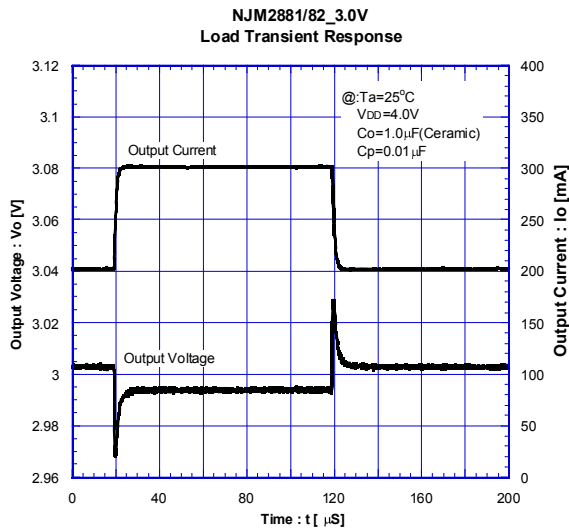
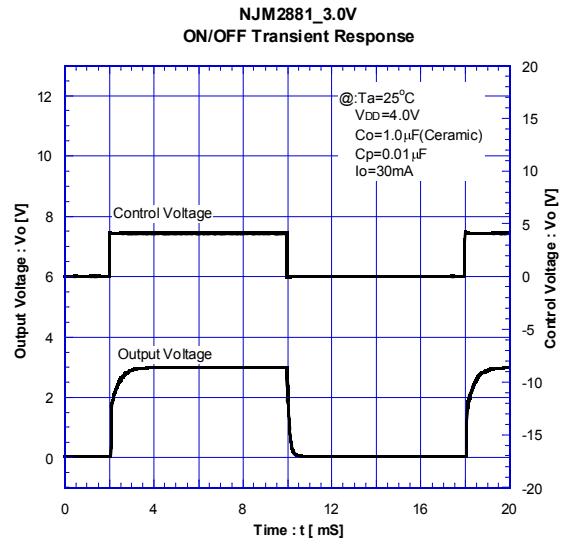
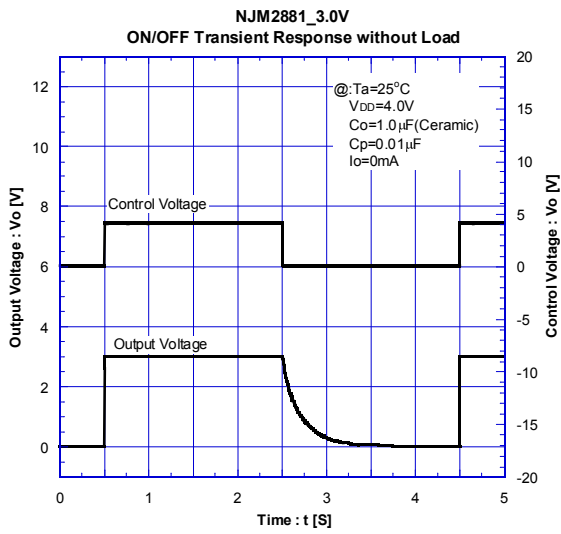

[CAUTION]

The specifications on this databook are only given for information, without any guarantee as regards either mistakes or omissions. The application circuits in this databook are described only to show representative usages of the product and not intended for the guarantee or permission of any right including the industrial rights.