

OLGA-M

~30° spot beam beam. Assembly with holder and installation tape.

TECHNICAL SPECIFICATIONS:

Dimensions	Ø 32.0 mm
Height	19.1 mm
Fastening	tape, pin
Colour	black
Box size	476 x 273 x 292 mm
Box weight	9.8 kg
Quantity in Box	792 pcs
ROHS compliant	yes ⓘ



MATERIAL SPECIFICATIONS:

Component	Type	Material	Colour
OLGA-M	Single lens	PMMA	clear
OLGA-HLD	Holder	PC	black
SPUTNIK-TAPE3	Tape	PU tape	black

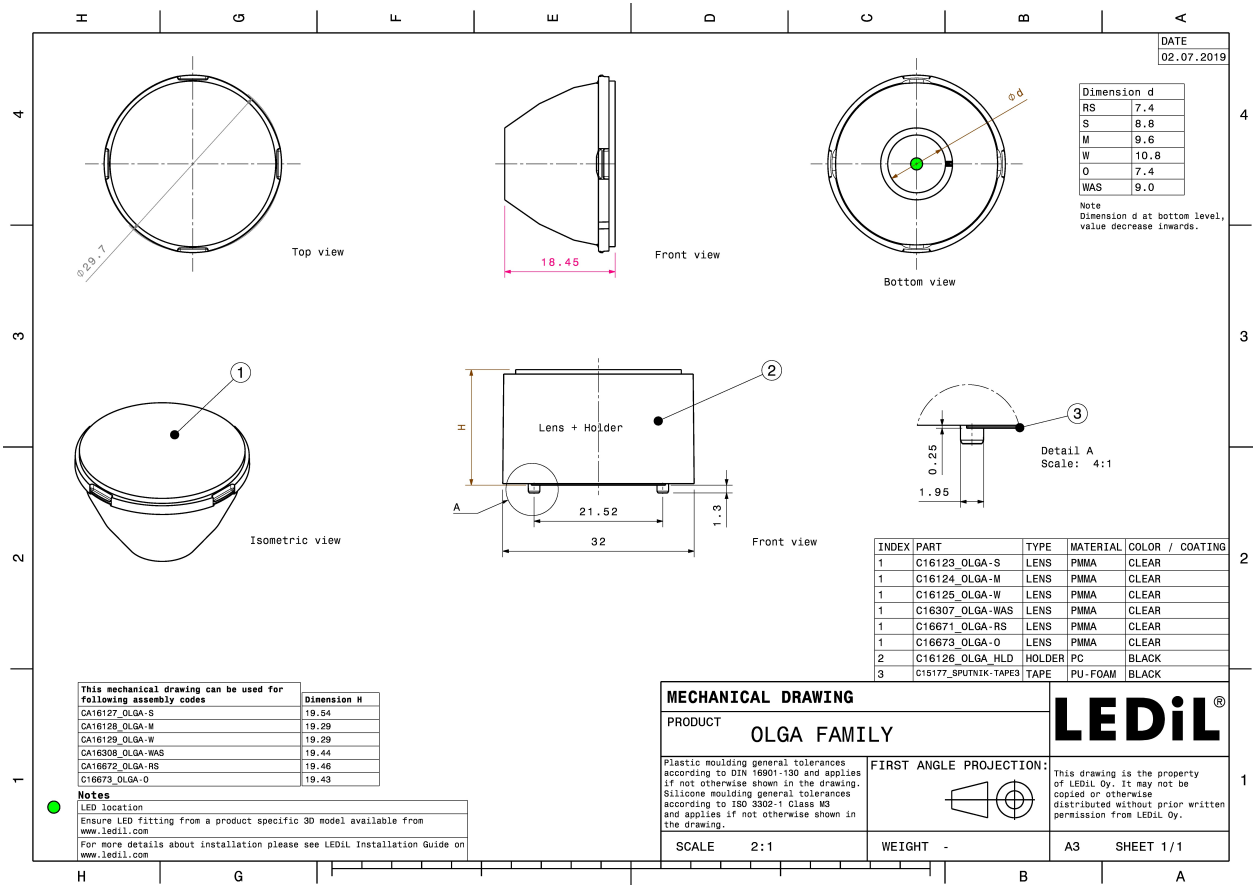

PHOTOMETRIC DATA (MEASURED):

CREE 

LED XD16
 FWHM 26.0°
 Efficiency 80 %
 Peak intensity 3.200 cd/lm
 LEDs/each optic 1
 Light colour White
 Required components:

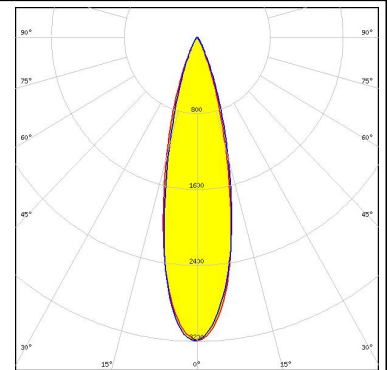

CREE 

LED XHP35 HD
 FWHM 32.0°
 Efficiency 80 %
 Peak intensity 2.100 cd/lm
 LEDs/each optic 1
 Light colour White
 Required components:

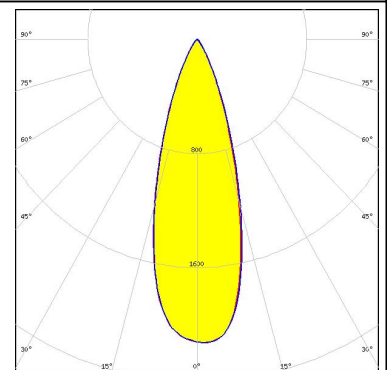
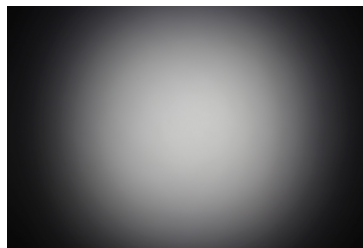

CREE 

LED XHP35 HI
 FWHM 28.0°
 Efficiency 84 %
 Peak intensity 2.800 cd/lm
 LEDs/each optic 1
 Light colour White
 Required components:

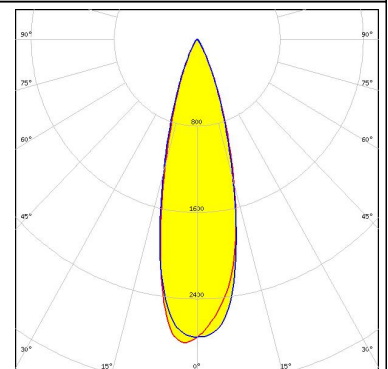
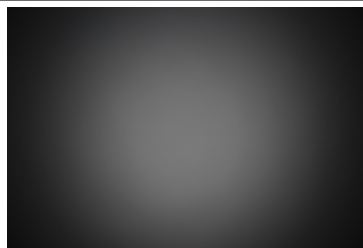

CREE 

LED XHP50
 FWHM 32.0°
 Efficiency 81 %
 Peak intensity 2.100 cd/lm
 LEDs/each optic 1
 Light colour White
 Required components:

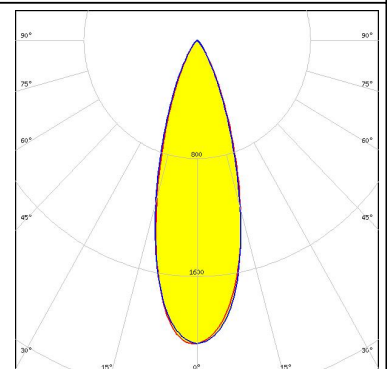
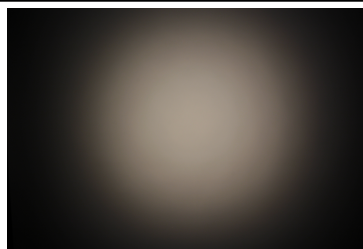

PHOTOMETRIC DATA (MEASURED):

CREE 

LED XHP50.2
FWHM 31.0°
Efficiency 81 %
Peak intensity 2.300 cd/lm
LEDs/each optic 1
Light colour White
Required components:

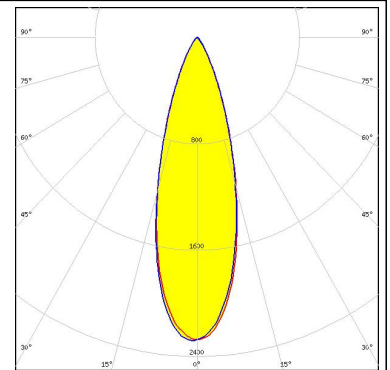
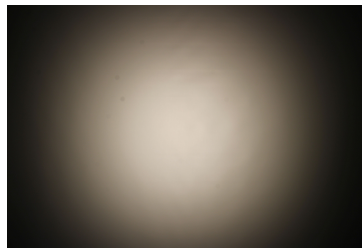

CREE 

LED XHP70
FWHM 33.0°
Efficiency 82 %
Peak intensity 2.000 cd/lm
LEDs/each optic 1
Light colour White
Required components:

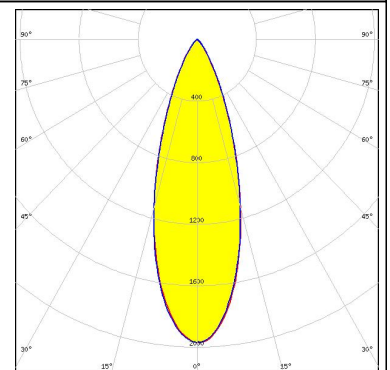
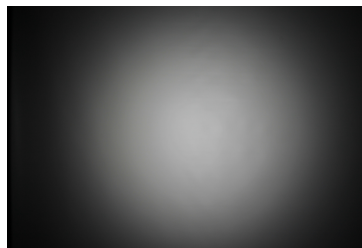

CREE 

LED XHP70.2
FWHM 34.0°
Efficiency 81 %
Peak intensity 1.900 cd/lm
LEDs/each optic 1
Light colour White
Required components:

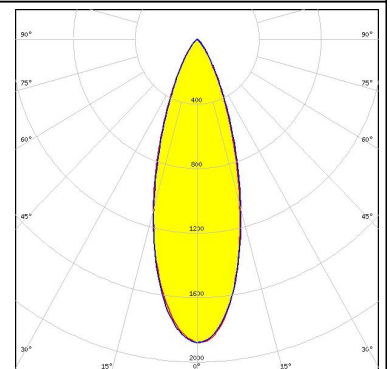
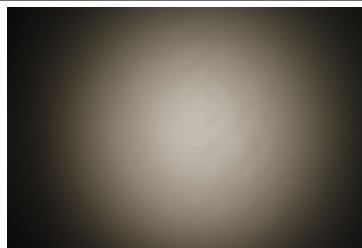

CREE 

LED XM-L
FWHM 31.0°
Efficiency 83 %
Peak intensity 2.400 cd/lm
LEDs/each optic 1
Light colour White
Required components:

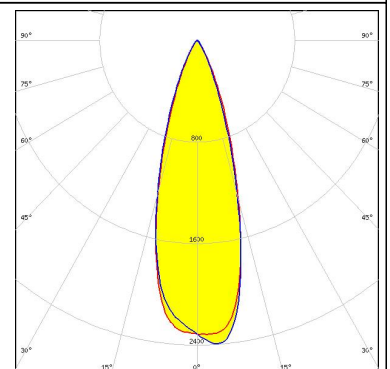
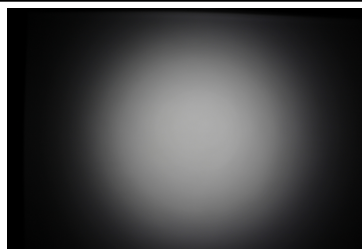

PHOTOMETRIC DATA (MEASURED):

CREE 

LED XP-G2
 FWHM 30.0°
 Efficiency 83 %
 Peak intensity 2.700 cd/lm
 LEDs/each optic 1
 Light colour White
 Required components:

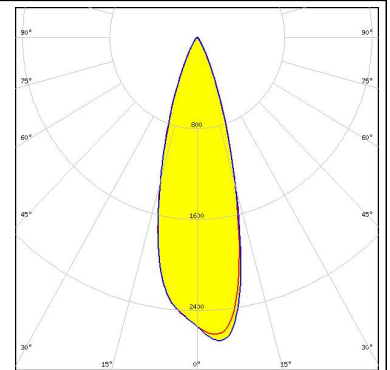

CREE 

LED XP-G3
 FWHM 31.0°
 Efficiency 82 %
 Peak intensity 2.500 cd/lm
 LEDs/each optic 1
 Light colour White
 Required components:

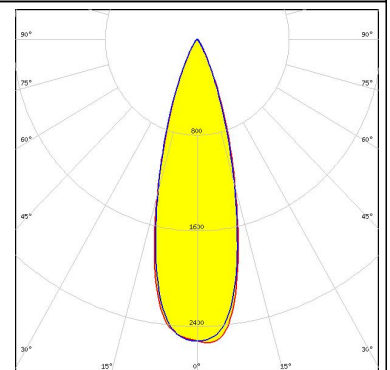
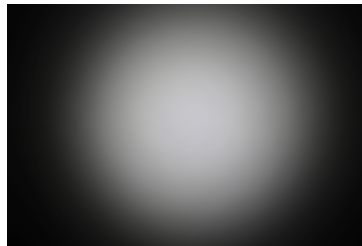

CREE 

LED XP-L HI
 FWHM 28.0°
 Efficiency 85 %
 Peak intensity 3.000 cd/lm
 LEDs/each optic 1
 Light colour White
 Required components:

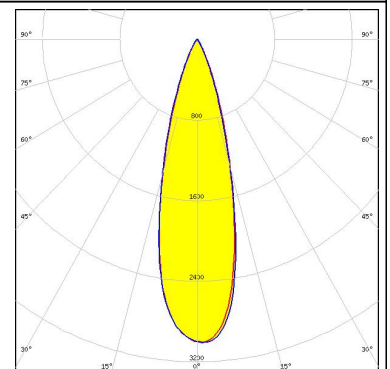

CREE 

LED XP-L2
 FWHM 30.0°
 Efficiency 81 %
 Peak intensity 2.500 cd/lm
 LEDs/each optic 1
 Light colour White
 Required components:

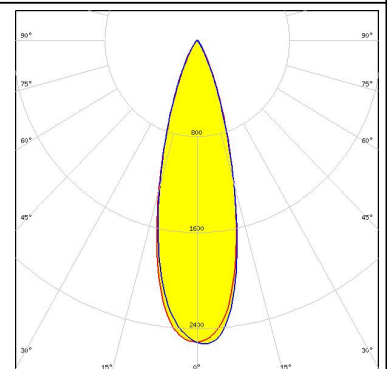
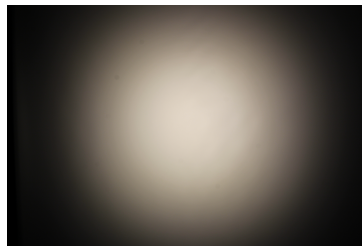

PHOTOMETRIC DATA (MEASURED):



LED XQ-E HD
 FWHM 28.0°
 Efficiency 76 %
 Peak intensity 2.800 cd/lm
 LEDs/each optic 1
 Light colour White
 Required components:

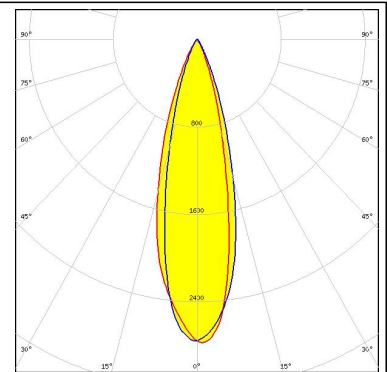

LED XQ-E HI
 FWHM 27.0°
 Efficiency 83 %
 Peak intensity 3.100 cd/lm
 LEDs/each optic 1
 Light colour White
 Required components:

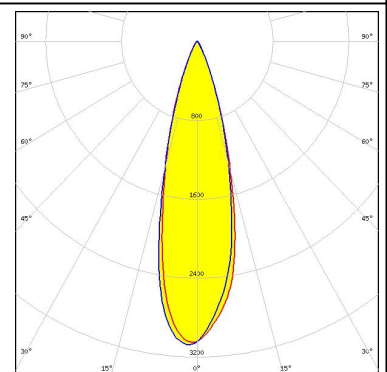
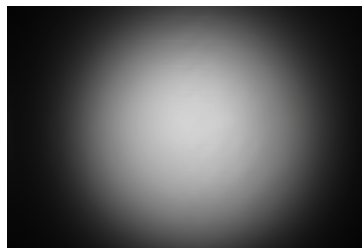

LED XT-E
 FWHM 29.0°
 Efficiency 79 %
 Peak intensity 2.600 cd/lm
 LEDs/each optic 1
 Light colour White
 Required components:

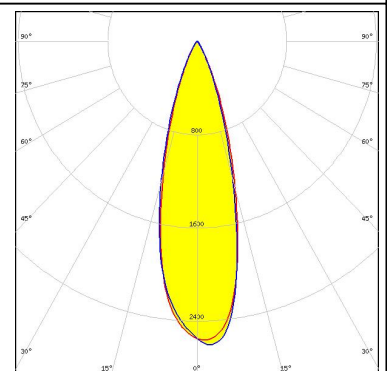
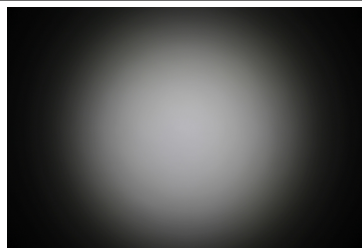

LED LUXEON 5050 Round LES
 FWHM 27.0°
 Efficiency 86 %
 Peak intensity 3.000 cd/lm
 LEDs/each optic 1
 Light colour White
 Required components:

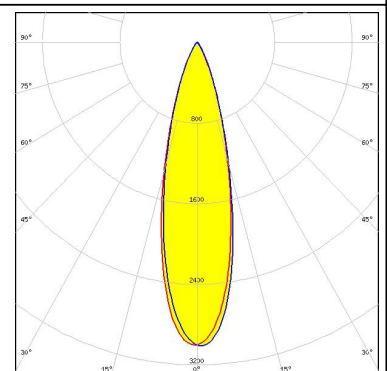
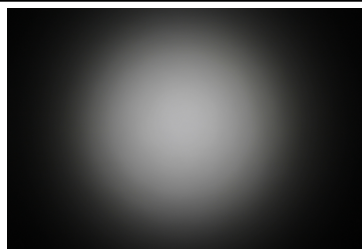

PHOTOMETRIC DATA (MEASURED):

LUMILEDS

LED LUXEON C
 FWHM 29.0°
 Efficiency 76 %
 Peak intensity 2.600 cd/lm
 LEDs/each optic 1
 Light colour White
 Required components:

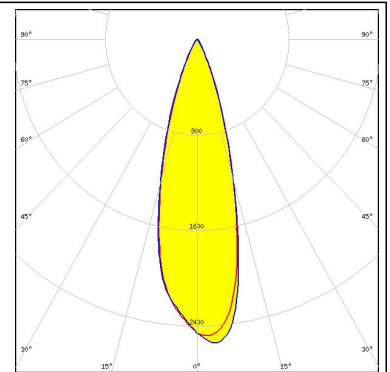
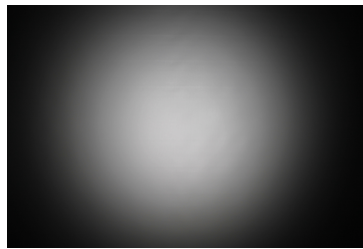

LUMILEDS

LED LUXEON CZ
 FWHM 26.0°
 Efficiency 85 %
 Peak intensity 3.500 cd/lm
 LEDs/each optic 1
 Light colour White
 Required components:

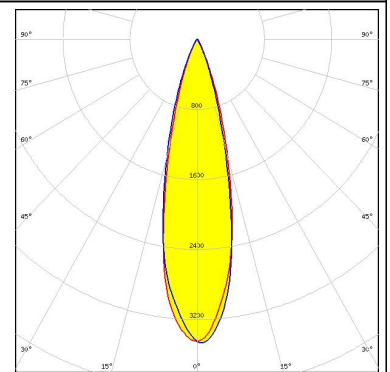
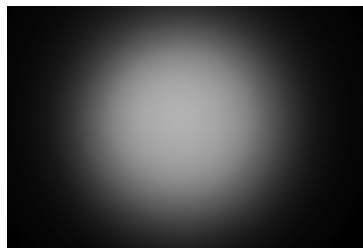

LUMILEDS

LED LUXEON M/MX
 FWHM 31.0°
 Efficiency 84 %
 Peak intensity 2.300 cd/lm
 LEDs/each optic 1
 Light colour White
 Required components:

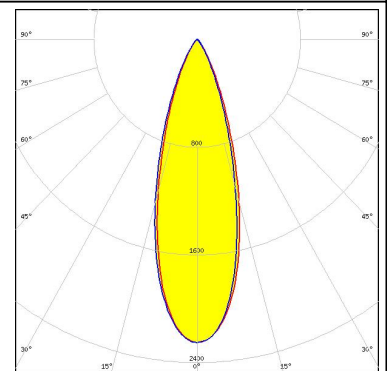
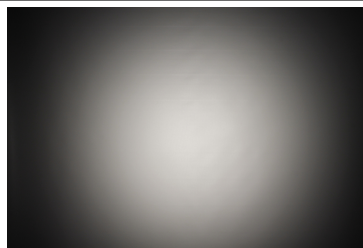

LUMILEDS

LED LUXEON MZ
 FWHM 26.0°
 Efficiency 85 %
 Peak intensity 3.100 cd/lm
 LEDs/each optic 1
 Light colour White
 Required components:

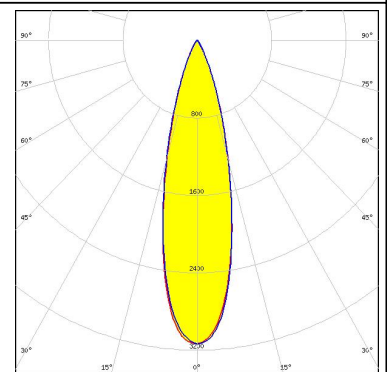
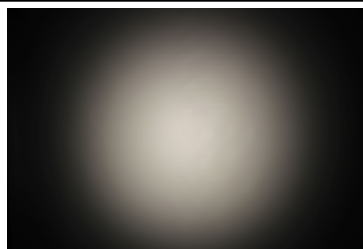

PHOTOMETRIC DATA (MEASURED):

LUMILEDS

LED LUXEON Rebel ES
 FWHM 28.0°
 Efficiency 83 %
 Peak intensity 3.000 cd/lm
 LEDs/each optic 1
 Light colour White
 Required components:

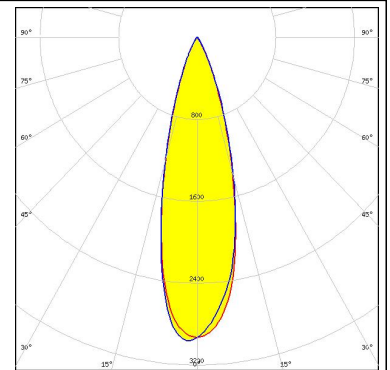

LUMILEDS

LED LUXEON TX
 FWHM 29.0°
 Efficiency 83 %
 Peak intensity 2.900 cd/lm
 LEDs/each optic 1
 Light colour White
 Required components:

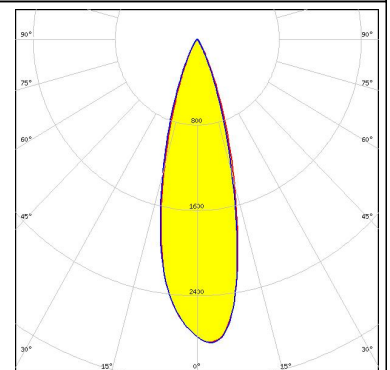
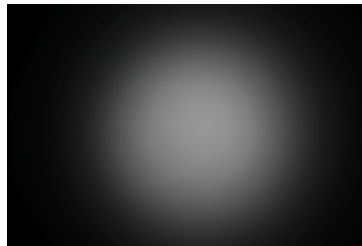

LUMILEDS

LED LUXEON V
 FWHM 29.0°
 Efficiency 82 %
 Peak intensity 2.600 cd/lm
 LEDs/each optic 1
 Light colour White
 Required components:

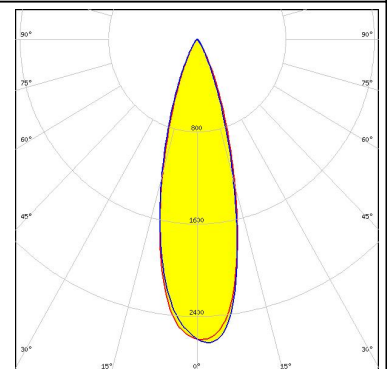
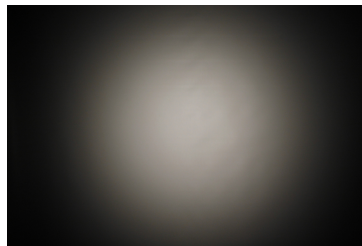

LUMILEDS

LED LUXEON V
 FWHM 28.0°
 Efficiency 82 %
 Peak intensity 2.700 cd/lm
 LEDs/each optic 1
 Light colour White
 Required components:

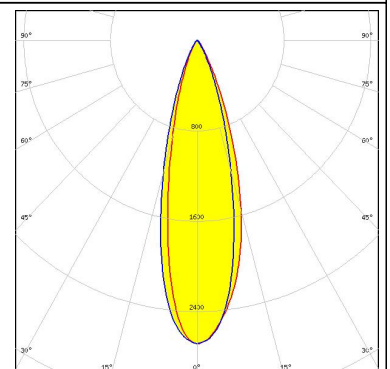
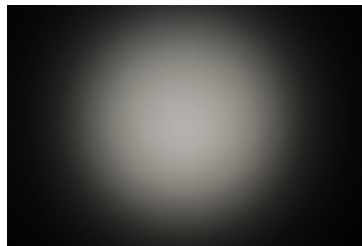

PHOTOMETRIC DATA (MEASURED):

LUMILEDS

LED LUXEON V2
 FWHM 29.0°
 Efficiency 83 %
 Peak intensity 2.900 cd/lm
 LEDs/each optic 1
 Light colour White
 Required components:

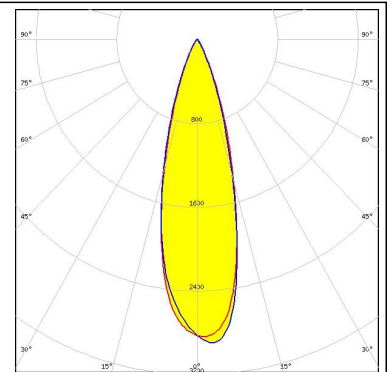
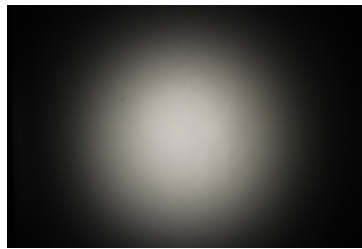

LUMILEDS

LED LUXEON Z
 FWHM 25.0°
 Efficiency 85 %
 Peak intensity 3.700 cd/lm
 LEDs/each optic 1
 Light colour White
 Required components:

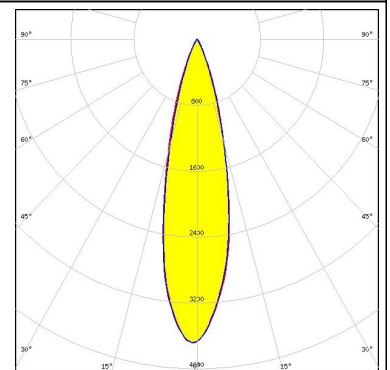
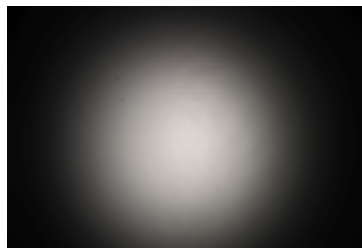

LUMILEDS

LED LUXEON Z ES
 FWHM 27.0°
 Efficiency 85 %
 Peak intensity 3.300 cd/lm
 LEDs/each optic 1
 Light colour White
 Required components:

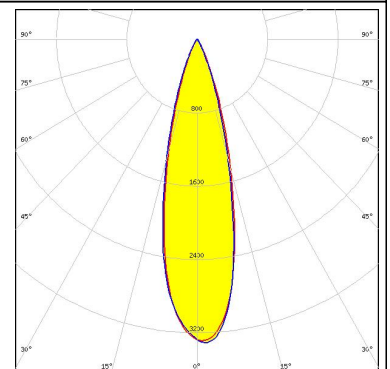
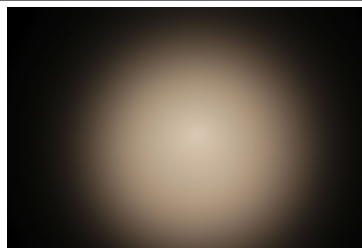

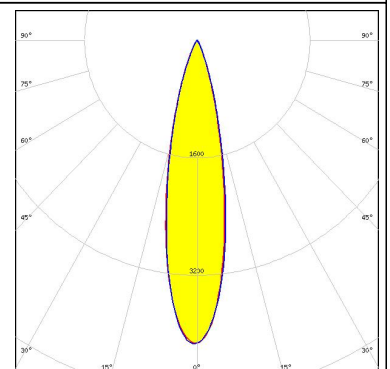
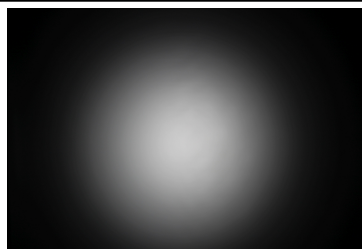

NICHIA

LED NCSxE17A
 FWHM 23.0°
 Efficiency 85 %
 Peak intensity 4.100 cd/lm
 LEDs/each optic 1
 Light colour White
 Required components:

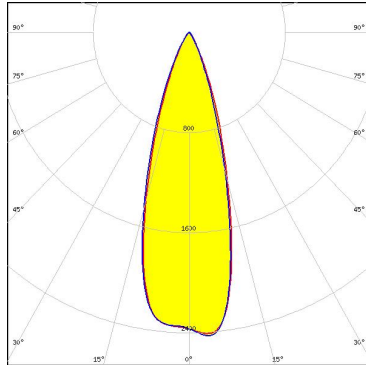
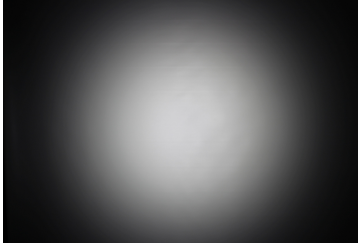
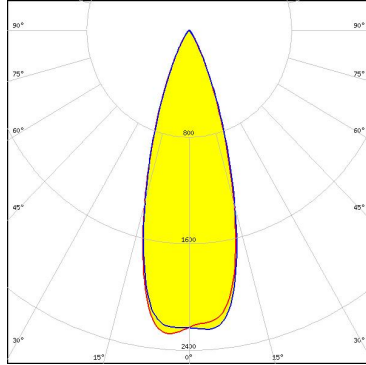
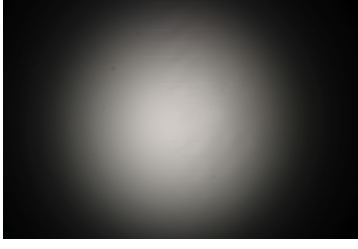
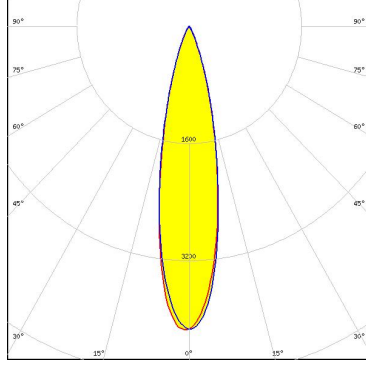

PHOTOMETRIC DATA (MEASURED):

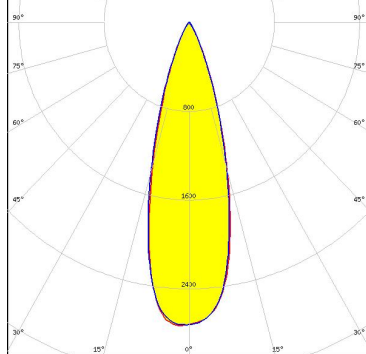
<p>NICHIA</p> <p>LED NVSW219D FWHM 31.0° Efficiency 83 % Peak intensity 2.400 cd/lm LEDs/each optic 1 Light colour White Required components:</p>		
<p>NICHIA</p> <p>LED NVSW319B FWHM 34.0° Efficiency 84 % Peak intensity 2.300 cd/lm LEDs/each optic 1 Light colour White Required components:</p>		
<p>NICHIA</p> <p>LED NVSxE21A FWHM 23.0° Efficiency 85 % Peak intensity 4.200 cd/lm LEDs/each optic 1 Light colour White Required components:</p>		
<p>NICHIA</p> <p>LED NVSxx19B/NVSxx19C FWHM 30.0° Efficiency 84 % Peak intensity 2.700 cd/lm LEDs/each optic 1 Light colour White Required components:</p>		

PHOTOMETRIC DATA (MEASURED):

OSRAM Opto Semiconductors

LED Duris S8
 FWHM 27.0°
 Efficiency 85 %
 Peak intensity 2.950 cd/lm
 LEDs/each optic 1
 Light colour White
 Required components:

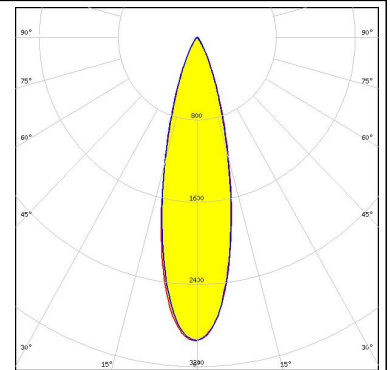

OSRAM Opto Semiconductors

LED OSCONIQ P 3737 (2W version)
 FWHM 26.0°
 Efficiency 83 %
 Peak intensity 3.200 cd/lm
 LEDs/each optic 1
 Light colour White
 Required components:

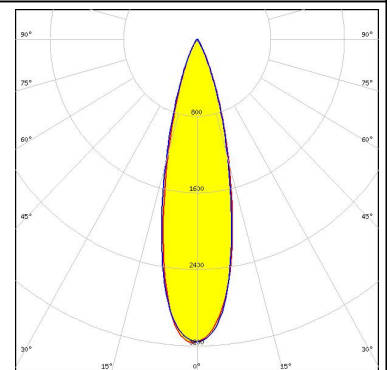
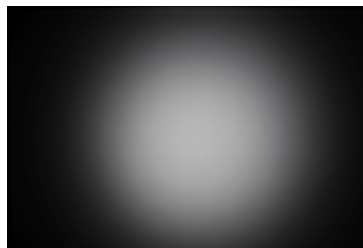

OSRAM Opto Semiconductors

LED OSCONIQ P 3737 (3W version)
 FWHM 28.0°
 Efficiency 84 %
 Peak intensity 3.000 cd/lm
 LEDs/each optic 1
 Light colour White
 Required components:

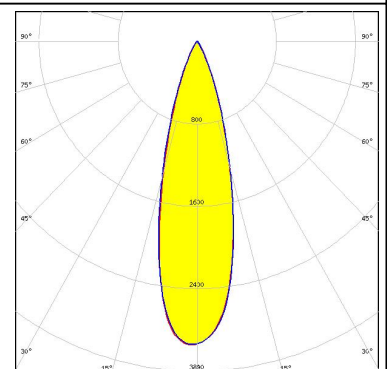
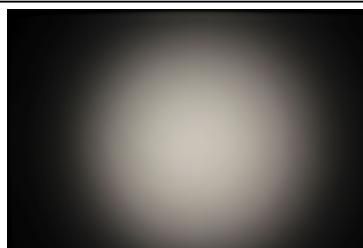

OSRAM Opto Semiconductors

LED OSCONIQ P 7070
 FWHM 29.0°
 Efficiency 83 %
 Peak intensity 2.600 cd/lm
 LEDs/each optic 1
 Light colour White
 Required components:

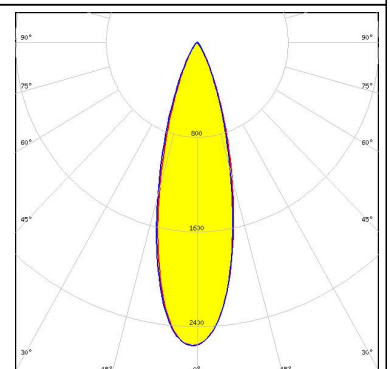
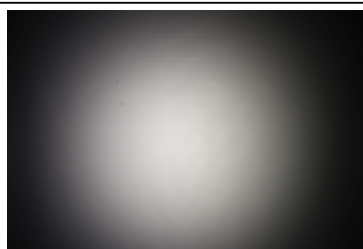

PHOTOMETRIC DATA (MEASURED):

OSRAM
Opto Semiconductors

LED OSLON Black Flat
FWHM 24.0°
Efficiency 85 %
Peak intensity 3.900 cd/lm
LEDs/each optic 1
Light colour White
Required components:

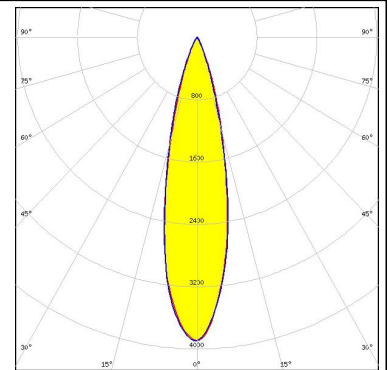
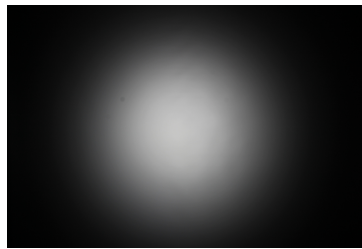

OSRAM
Opto Semiconductors

LED OSLON Square CSSRM2/CSSRM3
FWHM 30.0°
Efficiency 84 %
Peak intensity 2.700 cd/lm
LEDs/each optic 1
Light colour White
Required components:

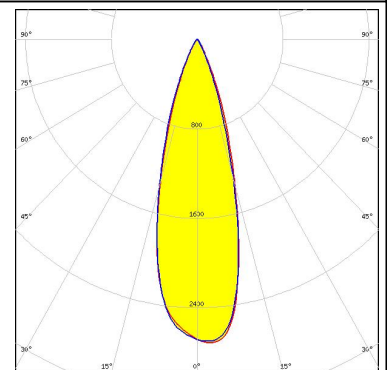
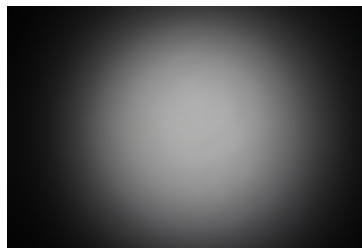

OSRAM
Opto Semiconductors

LED OSLON Square EC
FWHM 28.0°
Efficiency 81 %
Peak intensity 2.900 cd/lm
LEDs/each optic 1
Light colour White
Required components:

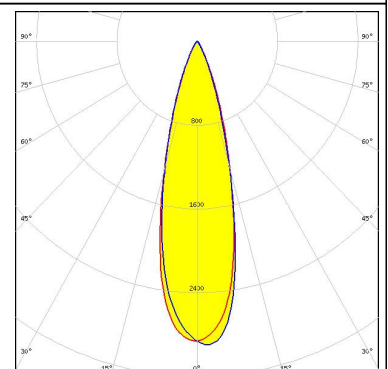
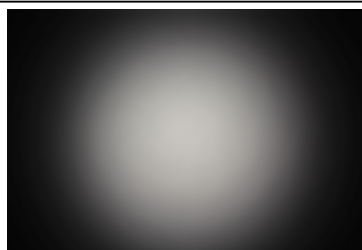

OSRAM
Opto Semiconductors

LED OSLON Square PC
FWHM 29.0°
Efficiency 82 %
Peak intensity 2.800 cd/lm
LEDs/each optic 1
Light colour White
Required components:

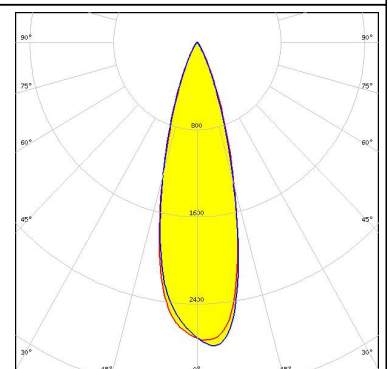
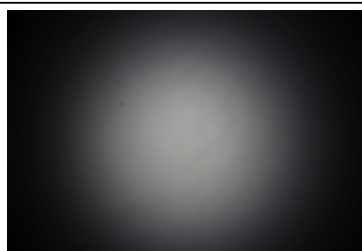

PHOTOMETRIC DATA (MEASURED):

OSRAM

Opto Semiconductors

LED OSLON SSL 150
 FWHM 30.0°
 Efficiency 82 %
 Peak intensity 2.700 cd/lm
 LEDs/each optic 1
 Light colour White
 Required components:

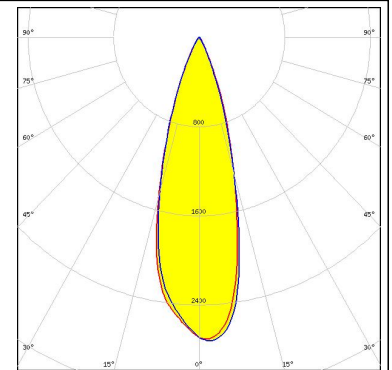

OSRAM

Opto Semiconductors

LED OSLON SSL 80
 FWHM 28.0°
 Efficiency 82 %
 Peak intensity 2.900 cd/lm
 LEDs/each optic 1
 Light colour White
 Required components:

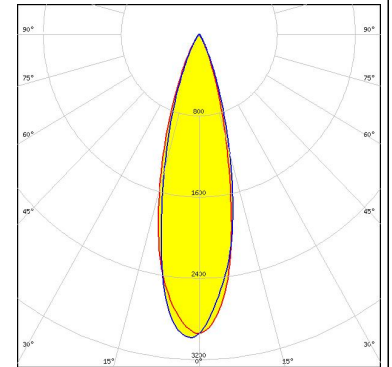
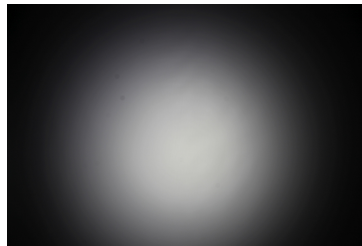

SAMSUNG

LED LH181A
 FWHM 22.0°
 Efficiency 81 %
 Peak intensity 4.000 cd/lm
 LEDs/each optic 1
 Light colour White
 Required components:

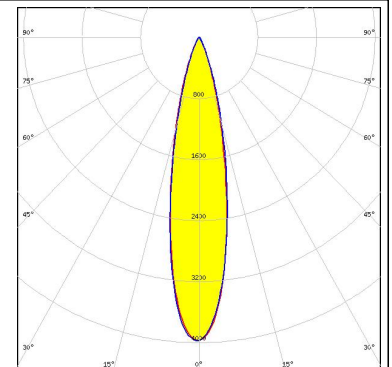
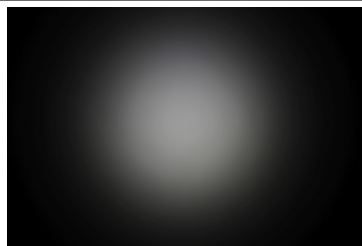

SAMSUNG

LED LH181B
 FWHM 23.0°
 Efficiency 85 %
 Peak intensity 3.400 cd/lm
 LEDs/each optic 1
 Light colour White
 Required components:

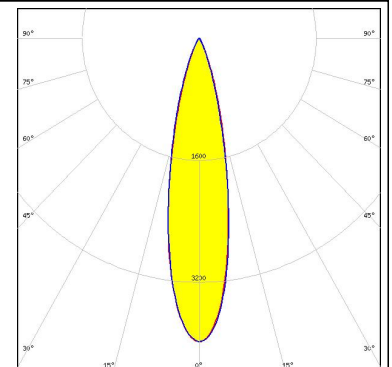
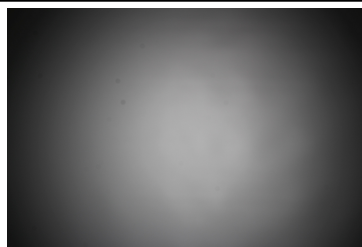

PHOTOMETRIC DATA (MEASURED):

SAMSUNG

LED LH231B
 FWHM 24.0°
 Efficiency 86 %
 Peak intensity 3.700 cd/lm
 LEDs/each optic 1
 Light colour White
 Required components:

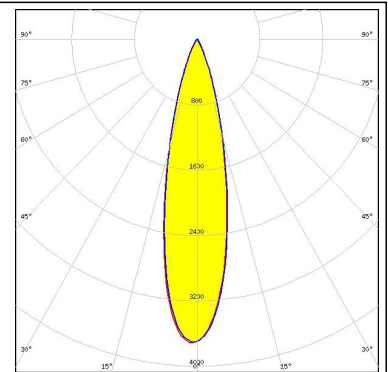

SAMSUNG

LED LH351B
 FWHM 30.0°
 Efficiency 84 %
 Peak intensity 2.700 cd/lm
 LEDs/each optic 1
 Light colour White
 Required components:

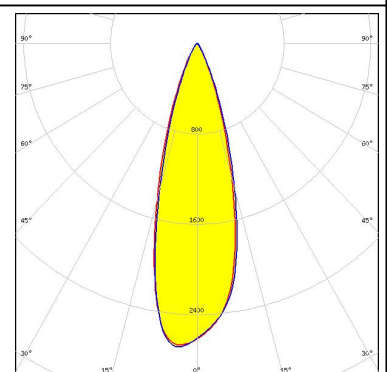
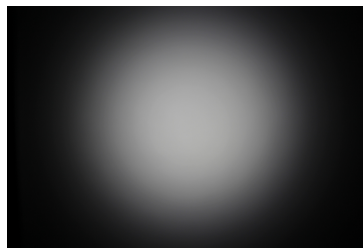

SAMSUNG

LED LH351C
 FWHM 31.0°
 Efficiency 85 %
 Peak intensity 2.700 cd/lm
 LEDs/each optic 1
 Light colour White
 Required components:

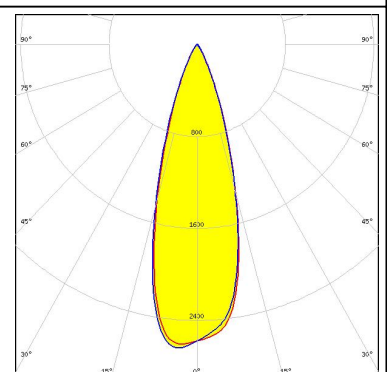
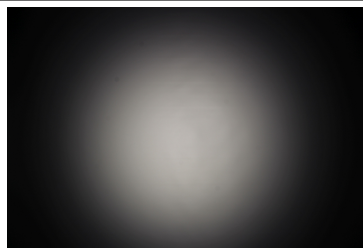

SAMSUNG

LED LH351D
 FWHM 33.0°
 Efficiency 83 %
 Peak intensity 2.200 cd/lm
 LEDs/each optic 1
 Light colour White
 Required components:

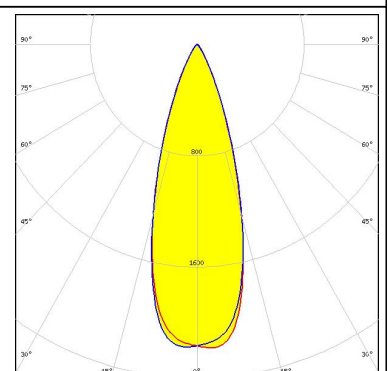
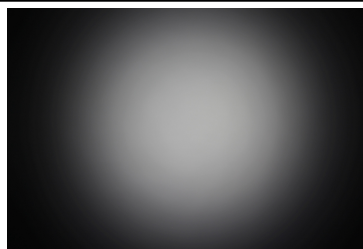

PHOTOMETRIC DATA (MEASURED):

SAMSUNG

LED LH508A
 FWHM 28.0°
 Efficiency 85 %
 Peak intensity 2.900 cd/lm
 LEDs/each optic 1
 Light colour White
 Required components:

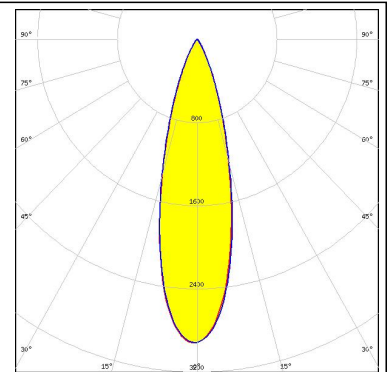

SAMSUNG

LED LM302A
 FWHM 25.0°
 Efficiency 85 %
 Peak intensity 3.400 cd/lm
 LEDs/each optic 1
 Light colour White
 Required components:

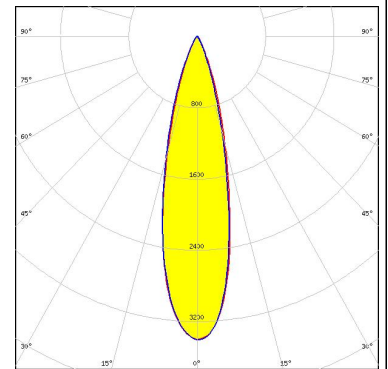
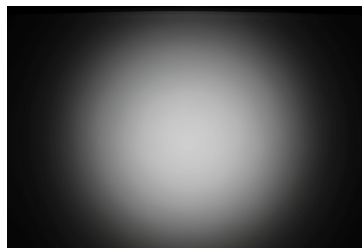

SAMSUNG

LED LM561B
 FWHM 27.0°
 Efficiency 85 %
 Peak intensity 3.200 cd/lm
 LEDs/each optic 1
 Light colour White
 Required components:

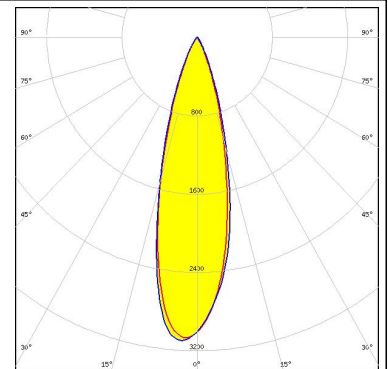
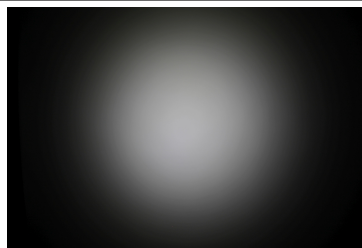

SEOUL SEMICONDUCTOR

LED Z5M3
 FWHM 28.0°
 Efficiency 82 %
 Peak intensity 2.800 cd/lm
 LEDs/each optic 1
 Light colour White
 Required components:

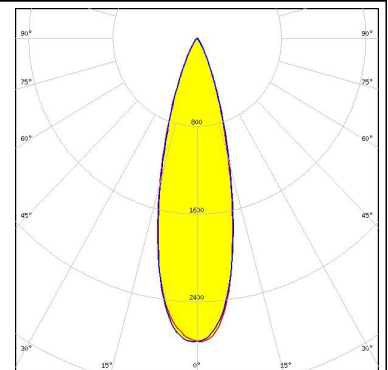
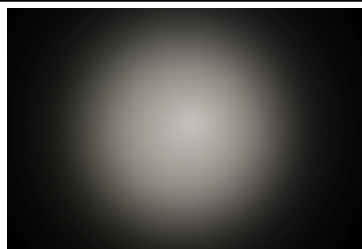

PHOTOMETRIC DATA (SIMULATED):



LED XHP50
 FWHM 28.0°
 Efficiency 91 %
 Peak intensity 3.549 cd/lm
 LEDs/each optic 1
 Light colour White
 Required components:

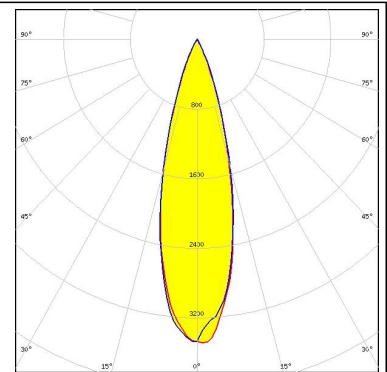

LED LUXEON MZ
 FWHM 22.0°
 Efficiency 91 %
 Peak intensity 5.407 cd/lm
 LEDs/each optic 1
 Light colour White
 Required components:

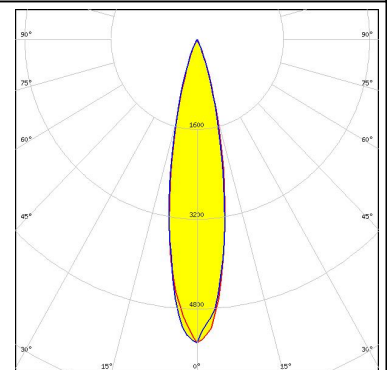

LED NFMW48xA
 FWHM 25.0°
 Efficiency 92 %
 Peak intensity 4.300 cd/lm
 LEDs/each optic 1
 Light colour White
 Required components:

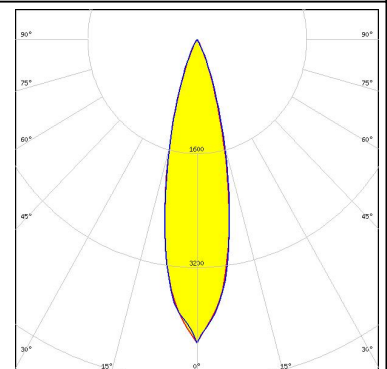

LED NV4x144A
 FWHM 31.0°
 Efficiency 86 %
 Peak intensity 2.740 cd/lm
 LEDs/each optic 1
 Light colour White
 Required components:

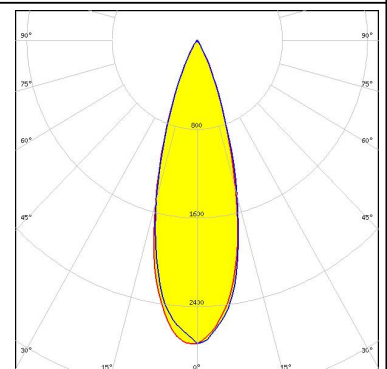

GENERAL INFORMATION:

NOTE: The typical beam angle will be changed by different color, chip size and chip position tolerance. The typical total beam angle is the full angle measured where the luminous intensity is half of the peak value.

MATERIALS:

As part of our continuous research and improvement processes, and to ensure the best possible quality and availability of our products, LEDiL reserves the right to change material grades without notice.

PRODUCT DATA USER AGREEMENT AND DISCLAIMER:

The measured data in the provided downloadable LEDiL Product Datasheets and Mechanical 2D-Drawings is rounded and provided as reference for planning. LEDiL Oy's optical specifications have been verified by conducting performance testing of the products in accordance with the company's quality system. The reported data are averaged results of multiple measurements with typical variation. LEDiL Oy reserves the right to without prior notification make changes and improvements to its products.

LEDiL Oy assumes neither warranty, nor guarantee nor any other liability of any kind for the contents and correctness of the provided data. The provided data has been generated with highest diligence but the provided data may in reality not represent the complete possible variation range of all intrinsic parameters. Therefore, in certain cases a deviation from the provided data could occur.

LEDiL Oy reserves the right to undertake technical changes of its products without further notification which could lead to changes in the provided data. LEDiL Oy assumes no liability of any kind for the possible deviation from any provided data or any other damage resulting from the usage of the provided data.

The user agrees to this disclaimer and user agreement with the download or usage of the provided files.

LEDiL Oy

Joensuunkatu 13
FI-24240 SALO
Finland

LEDiL Inc.

228 West Page Street
Suite D
Sycamore IL 60178
USA

Local sales and technical support

[www.ledil.com/
where_to_buy](http://www.ledil.com/where_to_buy)

Shipping locations

Salo, Finland
Hong Kong, China

Distribution Partners

[www.ledil.com/
where_to_buy](http://www.ledil.com/where_to_buy)